



VER 1.1 **Technical Manual**

DS-CLS9-FETC-2I



Table of Contents

1. Functional features.....	3
2. Technical parameters.....	3
3. Schematic diagram and interface definition.....	4
3.1 CN1 (power supply).....	4
3.2 CN2/CN6 (Axis 1 / Axis 2 motor wiring).....	4
3.3 CN3/CN7 (Axis 1 / Axis 2 holding brake output).....	4
3.4 CN4/CN8 (Axis 1 / Axis 2 encoder input).....	4
3.5 CN5/CN9 (Axis 1 / Axis 2 I/O port definition).....	5
3.6 CN12 MicroUSB B debug interface.....	5
3.7 CN13(OUT)/CN14(IN) (EtherCAT bus interface).....	6
3.8 Address assignment.....	7
3.9 Light.....	7
3.9.1 Status indication.....	7
3.9.2 Fault indication.....	7
4. Power supply.....	8
4.1 Voltage.....	8
4.2 Current.....	8
4.3 Regenerative discharge.....	8
5. Motor connection.....	9
6. Typical connection of signals.....	10
6.1 The input signal is connected using a switch or relay.....	10
6.2 The connection of the input signal to the NPN-type output.....	10
6.3 The connection method of the output signal sink current output.....	10
6.4 The connection method of the output signal sink current output is connected to the PLC input.....	11
6.5 The output signal is connected to the relay.....	11
7. Wiring requirements.....	12
8. Installation size (mm).....	12
9. Parameter description and settings.....	13
9.1 List of SDO parameters.....	13
9.1.1 Configure parameters.....	13
9.1.2 Motion parameters.....	15
10. Frequently used functions.....	16
10.1 Control word and operating mode.....	16
10.2 Probe capture function.....	20
10.3 Encoder resolution.....	22
10.4 Output peak current.....	23
10.5 603F failure code.....	23
Appendix 1 : Return to origin method.....	24
Appendix 2 : History of changes.....	42

1. Functional features

- ◆ Enter the power supply : DC 24V ~ 48V
- ◆ Motor output current per axis (peak) : 0.4 ~ 6.5A
- ◆ Supports up to 2-axis control
- ◆ Suitable for incremental open-loop and closed-loop motors
- ◆ EtherCAT communication control, support control mode PP, PV, TQ, HM, CSP, CSV
- ◆ Photocoupler input function
- ◆ Motor short circuit protection, undervoltage protection, overvoltage protection, overcurrent protection and other functions

2. Technical parameters

Drive model		DS-CLS9-FETC-2I
Adapts to motors		Suitable for two-phase hybrid incremental stepper motor, maximum adaptation 6.5A (peak)
Power supply		DC 24V~48V
Output current		0.4A~6.5A/phase (peak)
Drive mode		Full-bridge bipolar PWM driver
Device initialization time		2s
Input	1 probe input	Photocoupler input voltage: H = 24V, L = 0 - 0.8V Conduction current 5~8mA
Signal	3 universal input signals	
Output	2 universal output signals	Photocoupler output, maximum withstand voltage 30VDC, maximum saturation current 50mA
	Signal	1 way holding brake output Photocoupler output, maximum withstand voltage 30VDC, maximum saturation current 500mA
Size		156×97×34 mm (without connector)
Weight		About 500 g
Usage Environment	Occasions of use	Avoid dust, oil mist and corrosive gases
	Humidity	< 85 % RH, non-condensing
	Operating temperature	0°C ~ +40°C
	Storage temperature	-10°C ~ +75°C
	Cooling	Installed in a ventilated environment

3. Schematic diagram and interface definition

3.1 CN1 (power supply)

Terminal number	Icon	Pin.	Signal name
CN1		2	Power supply V+ DC24V~48V
		1	Power supply GND

Pay attention to the polarity of the power supply when wiring

Wire specifications: AWG20~AWG16 (multi-stranded wire)

3.2 CN2 / CN6 (Axis 1 / Axis 2 motor wiring)

Terminal number	Icon	Pin.	Signal name
CN2 / CN6		4	MotorA+
		3	MotorB+
		2	MotorA-
		1	MotorB-

3.3 CN3 / CN7 (Axis 1 / Axis 2 holding brake output)

Terminal number	Icon	Pin.	Signal name
CN3		2	BRK+ brake output is positive
		1	BRK - Negative brake output



Notes

1. The maximum output current is 500mA, no external relay is required
2. This function is turned off by factory by default, when this function is needed, please open and set the relevant parameters through the GUI program.

3.4 CN4 / CN8 (Axis 1 / Axis 2 encoder input)

Pin.	Signal name	Pin.	Signal name
1	A+	2	A-
3	B+	4	B-
5	Z+	6	Z-
7	+5V	8	0V
9	FG	10	NC

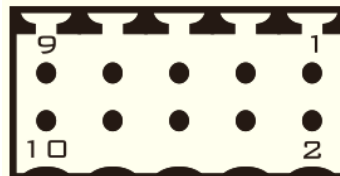

Diagram

Note : The driver outputs a 5V signal for the encoder, and the max. current is 200mA

3.5 CN5 / CN9 (Axis 1 / Axis 2 I/O port definition)

Icon :

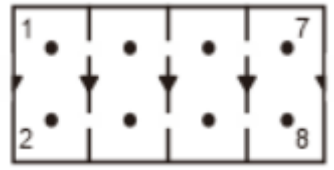

Terminal number	Pin	Signal name	Description
CN3	1	IN_COM	Single-ended input signal common end, common via 24VDC compatible
	2	TP1	High-speed input port, maximum input frequency 100KHz
	3	OUT_COM	Output Common Cathode Common Terminal (0V)
	4	IN1	Universal input port, 18~24V effective, maximum input frequency 1KHz, signal definition can be configured
	5	OUT1	Single-ended output signal, common cathode connection method, maximum output current 50mA, maximum withstand voltage 30Vdc. The output function is configurable
	6	IN2	Universal input port, 18~24V effective, maximum input frequency 1KHz, signal definition can be configured
	7	OUT2	Single-ended output signal, common cathode connection method, maximum output current 50mA, maximum withstand voltage 30Vdc. The output function is configurable
	8	IN3	Universal input port, 18~24V effective, maximum input frequency 1KHz, signal definition can be configured

3.6 CN12 MicroUSB B debug interface

	Notes	The USB to MicroUSB B debugging cable does not exceed 2 meters
--	--------------	--

3.7 CN13 (OUT) / CN14 (IN) (EtherCAT bus interface)

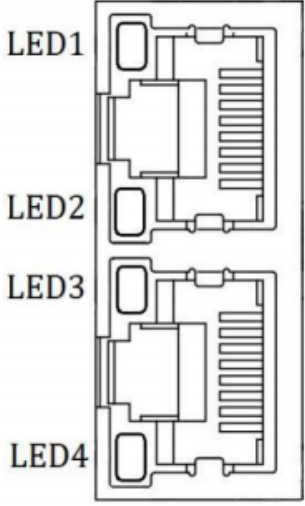
Terminal number	Pin	Signal name	Description	
CN8 / CN9		1, 9	E_TX+ EtherCAT data is sent on the positive side	
		2, 10	E_TX- EtherCAT data is sent to the negative side	
		3, 11	E_RX+ EtherCAT data receives the positive side	
		4, 12	- -	
		5, 13	- -	
		6, 14	E_RX- EtherCAT data receives the negative side	
		7, 15	- -	
		8, 16	- -	
		Connector housing	PE	The shield is grounded



Notes

RJ45 network port lamp definition description

LED logo	Name	Color	State	Description
LED1	Link / Activity IN	green	off	Physical layer links are not established
			on	The physical layer link is established
			flashing	Interact with data after the link is established
LED2	RUN	green	off	Initialization status
			flashing	Pre-operational status
			single flash	Security operation status
LED3	Link / Activity OUT	green	on	Operation status
			off	Physical layer links are not established
			flashing	The physical layer link is established
LED4	ERR	red	flashing	Interact with data after the link is established
			off	inerrancy
			slow flashing	The communication settings are incorrect
			single flash	Synchronization errors or communication data errors
			double flash	Request watchdog timeout
LED4	ERR	red	fast flashing	Boot error
			on	Internal bus watchdog timeout

3.8 Address assignment

The master assigns and address

3.9 Light

3.9.1 Status indication

Method : Complete the corresponding flashing (0.5 seconds low, 0.5 seconds high) times in different states, complete 2 seconds high, and then cycle.

Status features	Green light	Communication code	Illustrate
Stopping	flashing	2	On enabled, the motor is phase-locked but the motor is not running
In operation	Always on	3	The drive is running
Enable disconnect	flashing	1	The enable is disconnected and the motor can be free

3.9.2 Fault indication

Method : Complete the corresponding flashing (0.5 seconds low, 0.5 seconds high) times in different states, complete 2 seconds high, and then cycle.

Alarm function	Red light	Communication code	Illustrate
Motor overcurrent	Flashes 1 time	10	Motor phase current overcurrent or drive failure
The motor is out of phase	Flashes 2 times	11	The motor is not connected
Overvoltage	Flashes 3 times	14	The power input is greater than 60V
Undervoltage	Flashes 4 times	13	The power input is less than 18V
Position out of tolerance	Flashes 5 times	25 or 26	25 : The position deviation is greater than the set value 26 : The motor is overloaded, and the current is continuously output 1.5 times for more than 2 seconds
Other alarms	other	other	

4. Power supply

4.1 Voltage

The chopper driver constantly changes the magnitude and direction of the voltage at the winding terminal of the motor while sensing the current to obtain an accurate phase current. If high efficiency and low noise are to be guaranteed at the same time, the driver supply voltage is at least 5 times the rated phase voltage of the motor (i.e. the rated phase current \times phase resistance of the motor).

If you need better high-speed performance from your motor, you need to increase the drive supply voltage.

If a regulated power supply is used, the supply voltage must not exceed 48V.

If an unregulated power supply is used, the voltage required must not exceed 34V.

Because the rated current of the unregulated power supply is full load current; At light loads, such as when the motor is not spinning, the actual voltage is up to 1.4 times the rated voltage of the power supply. If you want the motor to run smoothly and quietly, choose low voltage.

4.2 Current

The maximum supply current should be the sum of the two phase currents. Typically, the current you need depends on the motor model, voltage, speed and load conditions. The actual supply current value is much lower than this maximum current value because the driver uses a switching amplifier to convert high voltage and low current into low voltage high current, and the more the supply voltage exceeds the motor voltage, the less supply current is required.

4.3 Regenerative discharge

When the motor slows down, it converts the kinetic energy of the load into electrical energy like a generator. Some of the energy is consumed by the drive and motor. If you have a large load running at high speed in your application, considerable kinetic energy will be converted into electrical energy. Typically, a simple linear power supply has a large capacitance to absorb this energy without causing damage to the system. Switching power supplies tend to shut down under overvoltage conditions, and excess energy is transferred back to the drive, which may cause damage to the drive. Therefore, in this case, an external absorption resistor or capacitor is required.

5. Motor Connection



Warning

When connecting the motor to the drive, first confirm that the drive is powered off. Verify that the unused motor leads are not shorted to other objects. The motor cannot be disconnected while the drive is energized. Do not connect the motor leads to ground or to the power supply.

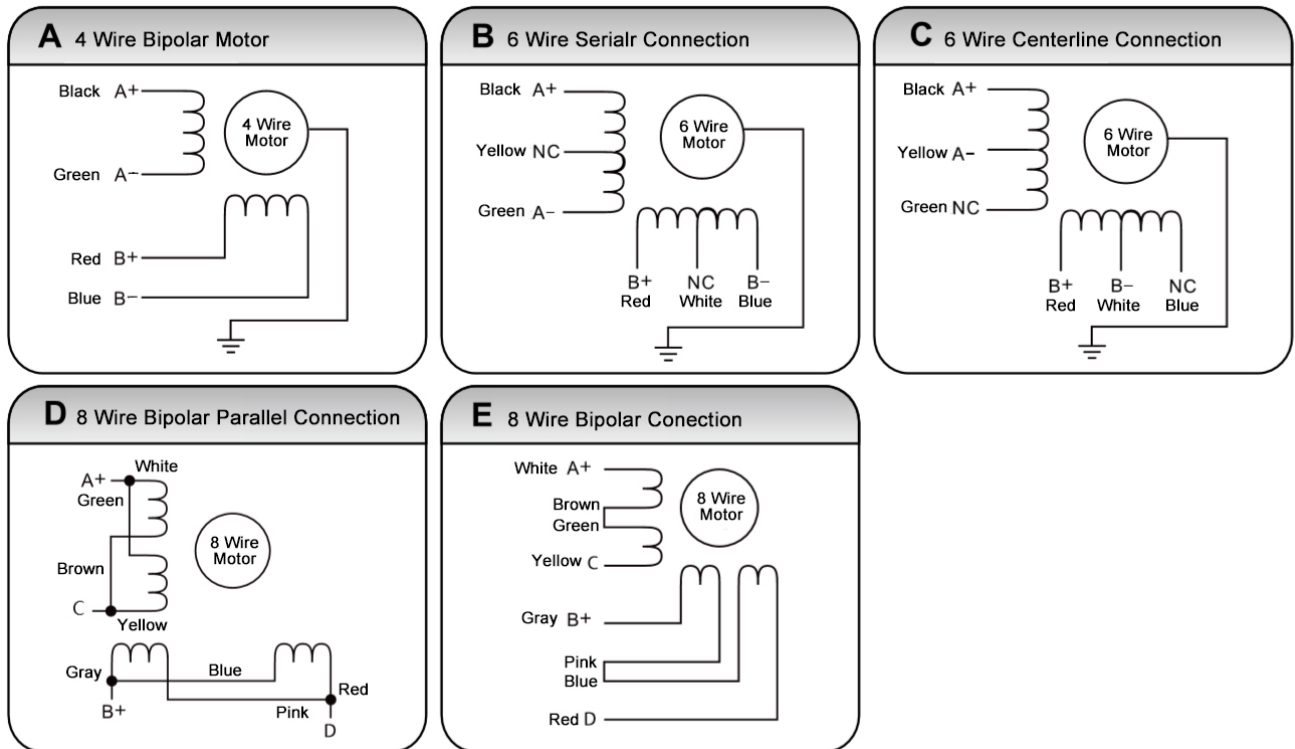

- 1) Four-wire motors can only be connected in one way.
- 2) Six-wire motors can be connected in two ways: full group and half group. In the full group mode, the motor has greater torque at low speeds, but it cannot run as fast as in the half group. When the whole group is running, the motor needs to run at less than 30% of the half-group current to avoid overheating.
- 3) Eight-wire motors can be connected in two ways: series and parallel. The series mode has greater torque at low speeds and less torque at high speeds. When running in series, the motor needs to run at 50% of the current in parallel to avoid overheating.



Notes

- 1) The corresponding color of different motor leads is different, and the motor data description shall prevail when using.
- 2) The windings of different phases of the motor cannot be connected to the terminals of the same phase of the drive (A+, A- are one phase, B+, B- are the other phase), if the motor steering is different from the expected steering, only exchange the position of A+ and A-.
- 3) This drive can only drive two-phase hybrid stepper motors, not three-phase and five-phase stepper motors.

6. Typical connection of signals

6.1 The input signal is connected using a switch or relay

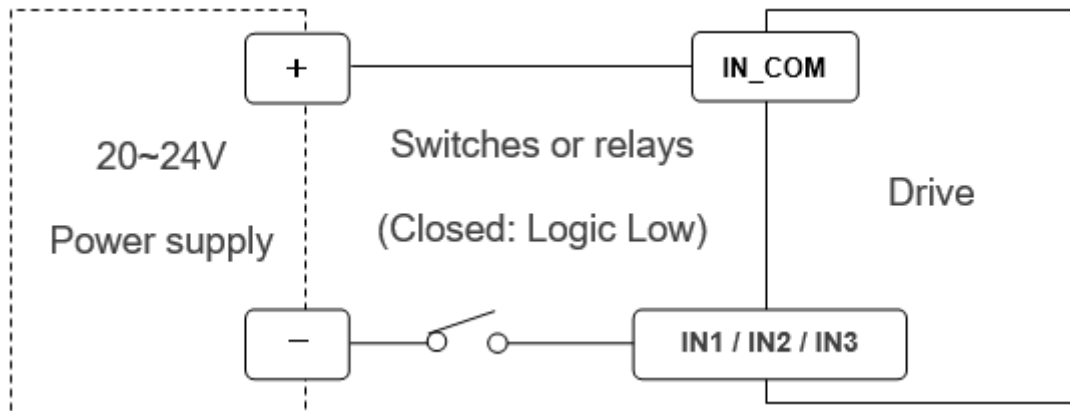

6.2 The connection of the input signal to the NPN-type output

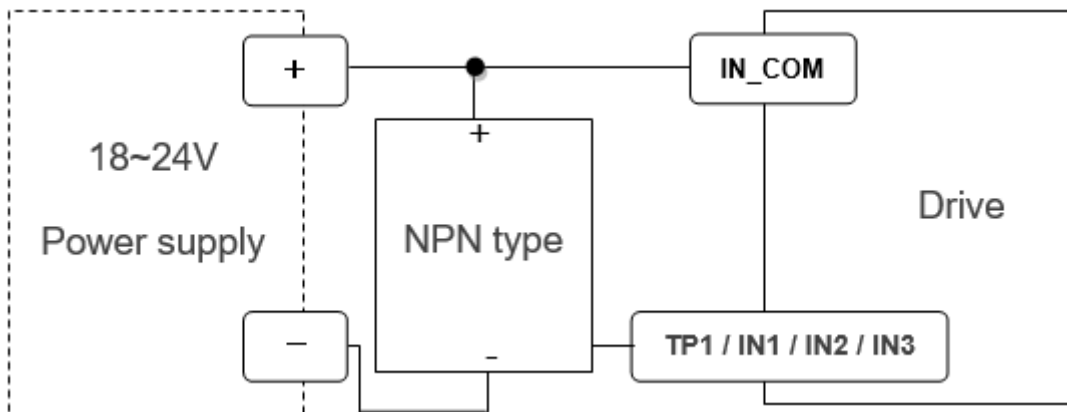

6.3 The connection method of the output signal sink current output

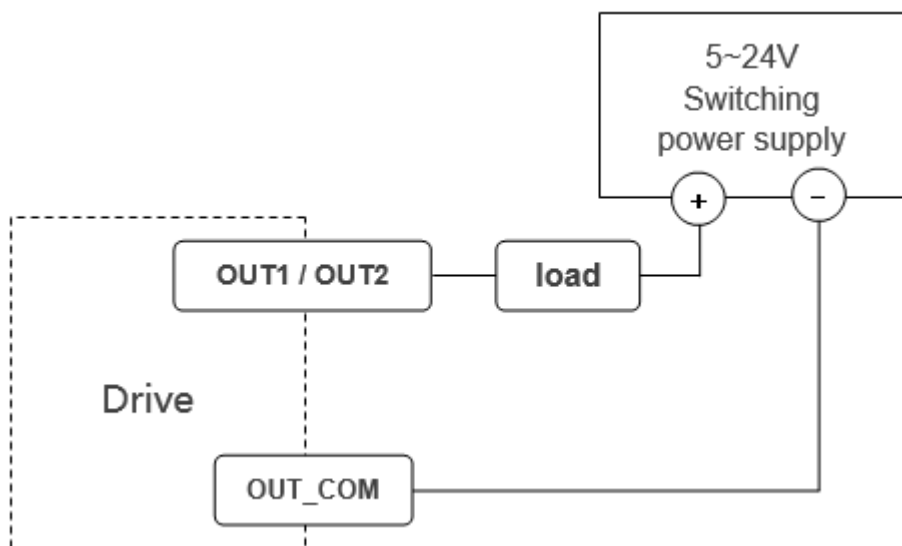

6.4 The connection method of the output signal sink current output is connected to the PLC input

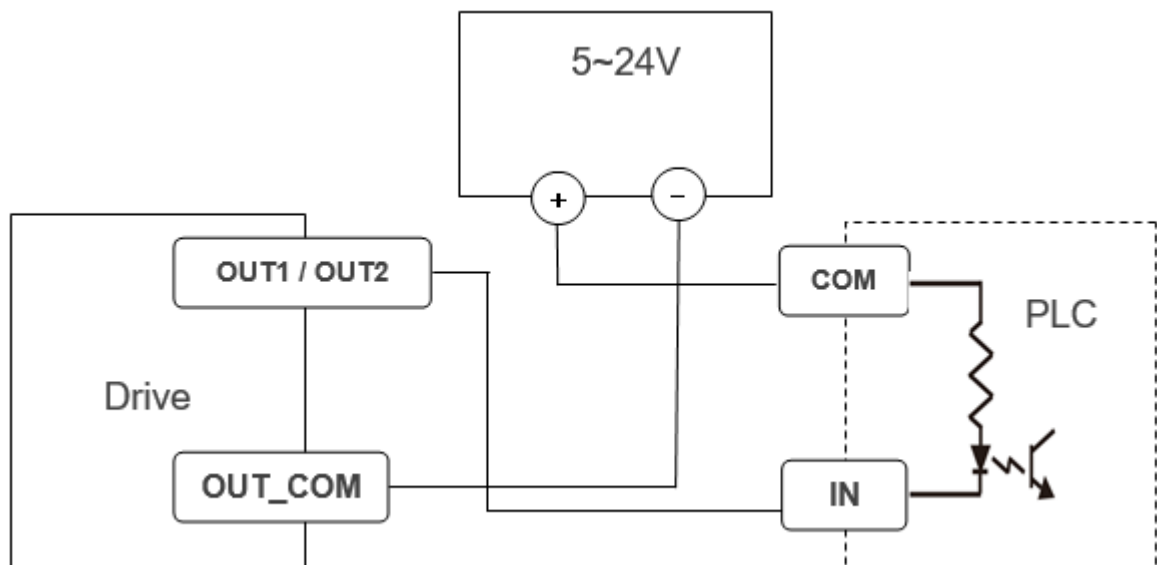

6.5 The output signal is connected to the relay

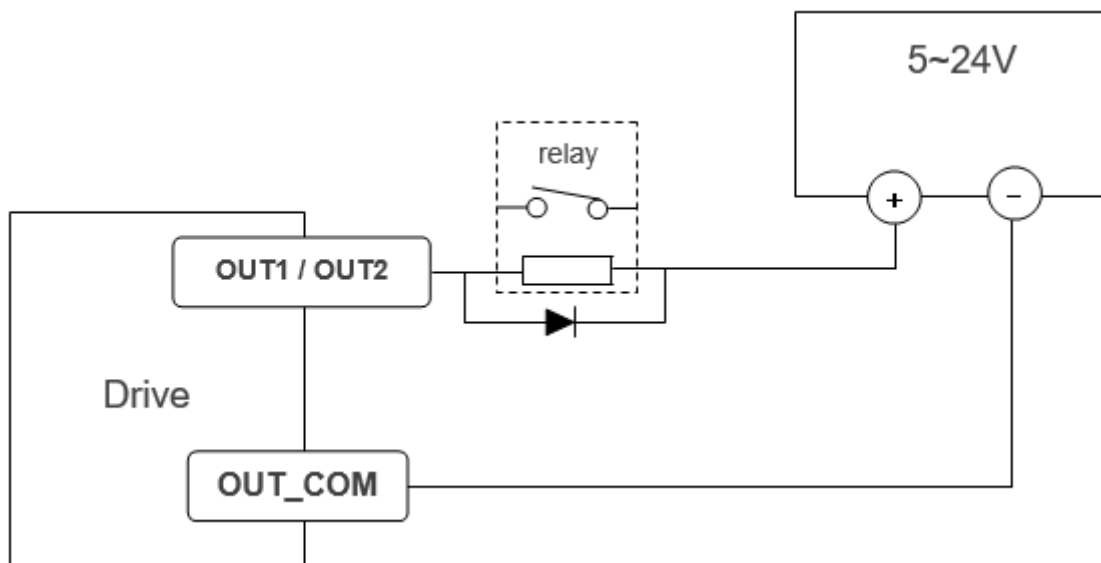

Warning Do not connect the output to a DC voltage above 30V, and do not flow more than 50mA into the output

7. Wiring requirements

- 1) In order to prevent the driver from being disturbed, it is recommended that the control signal use a shielded cable, and the shielding layer is shorted to the ground, except for special requirements, the shielded wire of the control signal cable is grounded on a single end: the host computer of the shielded wire is grounded, and the driver end of the shielded wire is suspended. Only the same point of grounding is allowed in the same machine, if it is not a real grounding wire, it may interfere seriously, and the shield is not connected at this time.
- 2) If one power supply is supplied to multiple drives, parallel connections should be taken at the power supply, and it is not allowed to connect one to another first.
- 3) It is strictly forbidden to unplug the strong current (motor and power) terminal of the drive with electricity, there is still a large current flowing through the coil when the live motor stops, and unplugging the strong current (motor and power) terminal will cause a huge instantaneous induced electromotive force to burn out the drive.
- 4) It is strictly forbidden to connect the wire end to the terminal after tinning, otherwise the terminal may be damaged due to overheating due to the large contact resistance.
- 5) The wiring end should not be exposed outside the terminal to prevent accidental short circuit and damage to the driver.

8. Installation size (unit : mm)

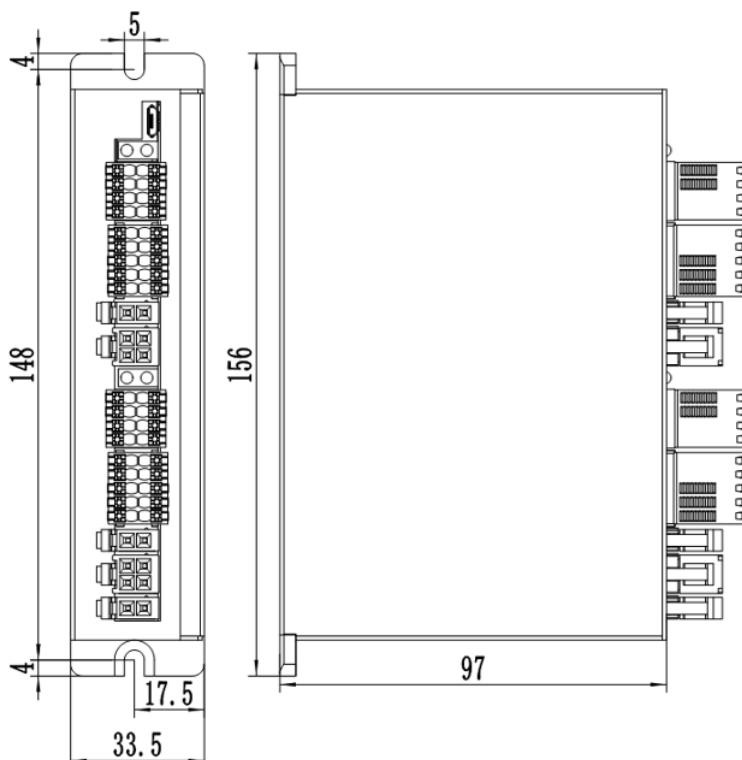

Drive installation

Install with narrow sides and M4 screws through holes on both sides. The power device of the driver will heat up, and if it is continuously operating under high input voltage and high power conditions, the effective heat dissipation area should be expanded or forced cooling.

Do not use in places where air is not circulating or where the ambient temperature exceeds 40°C. Do not install the drive in a damp or place with metal chips.

9. Parameter description and settings

9.1 List of SDO parameters

Bus-type closed-loop stepper drivers are standard EtherCAT slave devices that follow the EtherCAT standard protocol and can communicate with standard masters that support it.

The PC software interacts with the drive using the MODBUS protocol, and the PC software can modify/read all the parameters of the drive, alarm information and control the test operation of the drive

9.1.1 Configure parameters

The configuration parameter address consists of the base address and the axis number.

The starting number of each axis for the configuration parameter is calculated using the following formula.

Configuration parameter address = $0x2000 + (\text{axis number}-1) \times 0x200$

Axis number	Address
Axis 1	2000~21FF
Axis 2	2200~23FF

Let's take axis 1 as an example :

Object dictionary	Name	Attribute	Word	Range	Default value	Unit	Remark
2064	Rated current display	RO	1	0~65535	--		
2065	Busbar voltage	RO	1	0~65535	--		
206C	Error code	RO	1	0~65535	--		
206D	Running status	RO	1	0~65535	--		
206E	Hardware version	RO	1	0~65535	--		
206F	Software version	RO	1	0~65535	--		
20C9	Direction of operation	RW	1	0~3	0		Select the motor running direction and set the encoder direction: bit1=0: do not change the encoder direction, bit1=1: change the encoder direction; bit0=0: does not change the running direction, bit0=1: changes the running direction.
20CE	Control commands	RW	1	0~5	0		

20D5	Idle current	RW	1	10~120	50		The stop current is a percentage of the operating current.
20D9	Motor mode settings	RW	1	0~2	0		0: open loop, 1: Closed loop.
20E0	Filter factor	RW	1	0~500	50		The smaller the value, the smoother the motor runs, but the higher the latency.
20F1	Current setting	RW	1	0~3000	1000	0.1%A	
20F2	Resolution settings	RW	2	200~ 102400	10000	ppr	
20F5	Idle current time	RW	1	1~30000	200	ms	Time delay (ms) for entering a half-flow state after the motor has stopped running.
20F6	Encoder resolution	RW	1	200~65535	4000		Resolution = Number of encoder lines x 4.
20F7	Range in place	RW	1	1~1000	5		
2102	Location out-of-tolerance threshold	RW	1	1~30000	1000		Position out-of-tolerance threshold, which is the encoder resolution.
213D	Positive limit	RW	2	-2,000,000,000 ~2,000,000,000	2,000,000,000	pulse	
213F	Negative limit	RW	2	-2,000,000,000 ~2,000,000,000	-2,000,000,000	pulse	
2144	Memory control switch	RW	1	0~65535	0		bit0: Enables the forward soft limit function. bit1: Enables the reverse soft limit function.
2190	IN1 function selection	RW	1	0~23	0		
2191	IN2 function selection	RW	1	0~23	0		
2192	IN3 function selection	RW	1	0~23	0		
21A4	OUT1 function selection	RW	1	100~109	101		
21A5	OUT2 function selection	RW	1	100~109	101		
21AD	Enter the port logic	RW	1	0~65535	RW		
21AE	Output port logic	RW	1	0~256	RW		

9.1.2 Motion parameters

The motion parameter address consists of the base address and the axis number.

The starting numbers of each axis of the motion parameters are calculated using the following formula.

Motion parameter address = $0x6000 + (\text{axis number} - 1) \times 0x800$

Axis number	Address
Axis 1	6000~67FF
Axis 2	6800~6FFF

Let's take axis 1 as an example :

Object dictionary	Name	Attribute	Word	Range	Default value	Unit	Remark
603F	Error register	R	1	0~65535	0	--	
6040	Control words	R/W	1	0~65535	0	--	
6041	Status word	R	1	0~65535	0	--	
6060	Operating mode	R/W	1	0-255	1	--	1—PP 3—PV 4—TQ 6—HOME 8—CSP 9—CSV
6061	The operating mode is displayed	R	1	0-255	0	--	
6064	Physical location	R	2	-2147483647 ~ 2147483647	0	pulse	
606C	Actual speed	R	2	-2147483647~2147483647	0	0.01rps	
6071	Target torque	R/W	1	0~120	100	--	
6074	Torque requirements	R	1	0~65535	0	--	
6077	Actual torque	R	1	-32767~32767	0	--	
607A	Target location	R/W	2	-2147483647~2147483647	0	pulse	pp mode 1 target location instruction
607C	Origin offset	R/W	2	-2147483647~2147483647	0	pulse	
6081	Keystone speed	R/W	2	1~5000	100	0.01rps	PP mode 1 maximum speed
6083	Acceleration	R/W	2	1~5000	50	rps^2	PP, PV mode 1, 3 acceleration
6084	Deceleration	R/W	2	1~5000	50	rps^2	PP, PV mode 1, 3 deceleration
6087	Torque slope	R/W	2	1~10000	--	--	
6098	Origin mode	R/W	1	0~ 100	21	--	
6099+1	The origin is close to the velocity	R/W	2	1~5000	200	0.01rps	

6099+2	Origin creep speed	R/W	2	1~5000	100	0.01rps	
609A	Return to zero acceleration and deceleration	R/W	2	5~10000	50	rps^2	
60B8	Probe control word	R/W	1	0~65535	0	None	Set up probe functionality
60B9	Probe status word	R	1	0~65535	0	None	Probe action status
60BA	Probe data 1	R	2	-2147483647~2147483647	0	P	Probe1 captures data on the rising edge
60BB	Probe data 2	R	2	-2147483647~2147483647	0	P	probe1 captures data on the falling edge
60FD	Enter the port status	R	2	0~4294967296	0	--	bit0: Negative limit bit1: Positive limit bit2: Origin bit16~18: Corresponds to IN1~IN3 status
60FE+1	General output	R/W	2	0~4294967296	0	--	
60FE+2	Match bits	R/W	2	0~4294967296	0	--	
60FF	Target speed	R/W	0	-5000~5000	0	-	CSV mode target speed

10. Frequently used functions

10.1 Control word and operating mode

In the synchronous motion mode, the master station performs trajectory planning and outputs the cycle instruction, and the driver receives the planning instruction of the master station according to the synchronization cycle, which is suitable for multi-axis synchronous motion. This product's synchronous motion mode supports cyclic synchronous position mode (CSP). Under the cyclic synchronous position mode (CSP), the trajectory planning is completed at the master station, and this product receives the position information sent by the master according to the synchronization cycle, and immediately transmits the position information to the drive when the synchronization signal arrives. The synchronization period supported by this product is: 1000 us, 2000 us, 4000 us.

The master station is only responsible for sending motion parameters and control commands; After receiving the motion start command of the main station, the closed-loop stepping driver of this product will plan the trajectory according to the motion parameters sent by the main station. In nonsynchronous motion mode, the movement between each motor axis is asynchronous. The non-synchronous motion modes of this product include protocol position mode (PP), protocol speed mode (PV) and origin mode (HM).

No matter which control mode, EtherCAT bus master and slave data interaction is realized through the object dictionary, data transmission mode has PDO and SDO two ways, in general, can only choose one, according to the control needs according to the real-time requirements and importance of data transmission is divided into three levels: must > recommended > OK. "Must" indicates that in this mode, the corresponding object dictionary must be configured as a PDO transport mode. "Suggested" indicates that in this mode, the corresponding object dictionary is recommended to be configured as the PDO transmission mode to ensure real-time data for better control requirements. If the control requirements are not high, data transmission can also be carried out by SDO communication. "Yes" means that in this mode, the corresponding object dictionary is generally transmitted through SDO communication, and does not have to be configured as PDO. The object dictionary associated with each control mode is shown in the following table.

Each control mode is associated with a dictionary of objects							
Control mode	Index + subindex	name	Data type	Access type	unit	PDO configuration	SDO correspondence
CSP mode (8)	6040-00h	Control words	U16	RW	-	Must	-
	607A-00h	Target location	I32	RW	pulse	Must	-
	6041-00h	Status word	U16	RO	-	Must	-
	6064-00h	Physical location	I32	RO	pulse	Must	-
	606C-00h	Actual speed	I32	RO	0.01rps	optional	optional
PP mode (1)	607A-00h	Target location	I32	RW	pulse	suggest	optional
	6081-00h	Maximum speed	U32	RW	0.01 rps	optional	optional
PV mode (3) PP mode (1) PV mode (3) in common	6040-00h	Control words	U16	RW	-	suggest	optional
	6083-00h	acceleration	I32	RW	rps ²	optional	optional
	6084-00h	Deceleration	U32	RW	rps ²	optional	optional
HOME Mode (6)	6040-00h	Control words	U16	RW	-	suggest	optional
	6098-00h	Homming method	I8	RW	-	optional	optional
	6099-01h	Fast speed	U32	RW	0.01 rps	optional	optional
	6099-02h	Slow speed	U32	RW	0.01 rps	optional	optional
	609A-00h	Origin acceleration	U32	RW	rps ²	optional	optional
	607C-00h	Origin offset	U32	RW	pulse	optional	optional
PP, PV and HOME Patterns are common	6041-00h	Status word	U16	RO	-	suggest	optional
	6064-00h	Physical location	I32	RO	pulse	suggest	optional
	606C-00h	Actual speed	I32	RO	0.01 rps	optional	optional
TQ mode	6040-00h	Control words	U16	RW	-	Must	optional-
	6041-00h	Status word	U16	RO	-	Must	optional-

	6071-00h	Target torque	I16	RW	-	Must	optional
	6074-00h	Torque requirements			-	suggest	optional
	6077-00h	Actual torque			-	suggest	optional
	6087-00h	Torque slope			-	Must	optional
Common to all modes	60B8-00h	Probe function	U16	RW	-	suggest	optional
	60B9-00h	Probe status	U16	RO	-	suggest	optional
	60BA-00h	Probe 1 captures the value	I32	RO	P	optional	optional
	60FD-00h	Digital input	U32	RO	-	suggest	optional
	603F-00h	The latest error code	U16	RO	P	suggest	optional
Other associated parameters	6060-00h	Operating mode	I8	RW	-	optional	optional
	60B0-00h	Position offset	I32	RW	-	optional	optional
	6082-00h	Take-off speed	U32	RW	0.01 rps	optional	optional
	6085-00h	Emergency stop deceleration	U32	RW	rps ²	optional	optional
	6061-00h	The operating mode is displayed	I8	RO	-	optional	optional

No matter which control mode is used to realize the drive control of the actuator, it is inseparable from the reading and writing of the control word 6040h and the two object dictionaries of the status word and 6041h, and the master-slave station realizes instruction delivery and status monitoring through these two object dictionaries as a medium. The following highlights the definitions of the bits of these two object dictionaries.

The control word (6040H) is defined as shown in the following table. The left half of the table describes bit4~6 and bit8, and their meaning depends on the operation mode, mainly controlling the operation execution or stop of each mode; The right half of the table describes bit0~3 and bit7, which manage the state transition changes of the 402 state machine to meet complex and diverse control needs. The status word (6041h) definition is shown in the status word (6041h) bit definition table. bit0~bit7 mainly displays the 402 state machine transition state, and bit8~bit15 mainly displays the motion execution or stop state in each control mode. The typical state transition enabled is as follows:

Initial (00h) ----- power-on (06h) ----- start (07h) ----- enable (0fh) ----- execute operation or pause (depending on the operating mode, combined with bit4~6 and bit8 Issue relevant control instructions). The state transitions that trigger the run control in each control mode are shown in the status transition table for each mode control operation

Control word (6040h) bit definition												
Mode / bit	15 ~9	8	6	5	4	7	3	2	1	0	Typical value	Action result
In common	-	Time out	Depends on the mode of operation			Alarm reset	Allow the operation	Quick stop	Voltage output	initiate		
CSP Mode 8	-	void	void	void	void	0	0(x)	1	1	0	06h	Get electricity
PP Mode 1	-	Decelerate to stop	Absolute	Trigger immediately	The new location point	0	0	1	1	1	07h	Initiate
PV Mode 3	-	Decelerate to stop	relatively	void	void	0	0(x)	0	1	0(x)	02h	Stop fast
HM mode 6	-	Decelerate to stop	void	void	Start the movement	0	1	1	1	1	0fh	Enable
not						1	0(x)	0(x)	0(x)	0(x)	80h	Clear
not						0	0	0	0	0	0	Initial

Additional notes for other bits:

Bit 2 Fast Stop trigger logic is 0 valid, note that it is distinguished from other triggered logic.

Bit 7 error reset trigger logic is valid for rising edge.

Bit 5 triggers the trigger logic immediately to be valid for the rising edge

Status word (6041h) bit definition								
Mode / 8 bits lower	7	6	5	4	3	2	1	0
Share	Retain	Not started	Quick stop	Power on	Alarm	Allow the operation	Initiate	Ready to start
Mode / 8 bits high	15	14	13	12	10	8	11	9
Share	Depends on the mode of operation						The limit is valid	Remote
CSP mode 8	void	void	void	Follow effectively	void	Abnormal stop	It is asserted when the hardware limit is in effect	Below PreOP is 0
PP mode 1	can trigger an answer	The parameter has 0	void	The new location point	Location arrived	Abnormal stop		
PV Mode 3	void	The parameter has 0	void	Response	Speed arrives	Quick stop		
HM mode 6	can trigger an answer	The parameter has 0	Wrong origin	The speed is 0	Location arrived	Abnormal stop		

Additional notes for other bits:

When the drive is powered on, bit 4 is asserted.

Bit 5 stops activation quickly and is valid at logic 0, as opposed to the logic of other bits.

Bit 9 is remote, showing the status of the communication state machine, which is 0 below ProOP, at which point the command of the control word (6040h) will not be executed.

Bit 11 limit, set only when the hardware limit is valid.

Bit 8 abnormal stop, generally valid in hardware limit, deceleration stop and fast stop trigger state.

Bit 12 follows the master, which is 0 under CSP if the drive is not enabled or no longer follows the master's instructions.

Each mode controls the state transition of the run										
Steps	0	1	2	3	4	5	6	7	8	
Mode	Action	Preparatory work	Initial	Get electricity	Initiate	Enable	Start running	Displacement	Stop it	Fault
CSP mode 8	6040	Establish the communication OP state and activate the NC axis	00h	06h	07h	0fh	The 1fh master sends instructions	Master control	Master stop position command	-
	6041		250h	231h	233h	1237h	1237h			1237h
PP mode 1	6040	Establish communication OP state and set motion parameters	00h	06h	07h	0fh	-	2fh->3fh	10fh	-
	6041		250h	231h	233h	8237h	1237h	1637h->1237h	1737h	1238h
PV mode 3	6040	Establish the pass OP state and set the motion parameters	00h	06h	07h	0fh	Run when enabled	Just change the speed	10fh	-
	6041		250h	231h	233h	1637h	1637h	1637h	1737h	1638h
HM mode 6	6040	Establish the pass OP state and set the motion parameters	00h	06h	07h	0fh	1fh	Invalid	10fh	-
	6041		250h	231h	233h	8337h	237h	237h	737h	238h

Additional notes for other bits:

When the PP mode changes position, it is necessary to give the bit5 rising edge of the control word to start a new position movement

10.2 Probe capture function

The probe function is to use the input signal with the probe function to capture the actual position of the motor and record it. The driver has two input IO signals that support probe functionality and can be enabled simultaneously. The dictionary of objects related to probe functions is shown in the following table.

Dictionary of objects related to probe functionality						
Object dictionary	Bit or object dictionary meaning					
	7~6	5	4	3~2	1	0
60B8h	-	Probe 1 is triggered by falling edge	Probe 1 is triggered on the rising edge	-	Probe 1 mode	Probe 1 is enabled
	15~14	13	12	11~10	9	8
	-	Probe 2 is triggered by falling edge	Probe 2 rising edge trigger	-	Probe 2 mode	Probe 2 is enabled
60B9h	7	6	5~3	2	1	0
	The actual level of probe 2	The actual level of probe 1		Probe 1 lower rising edge trigger complete	Probe 1 rising edge trigger complete	Probe 1 in action
	15~11			10	9	8
		-		Probe 2 lower rising edge trigger complete	Probe 2 rising edge trigger complete	Probe 2 in action
60BAh	Probe 1 captures the data value register on the rising edge					
60BBh	Probe 1 captures the data value register on the rising edge					
60BCh	Probe 2 captures the data value register on the rising edge					
60BDh	Probe 2 down the rising edge capture data value register					
60FDh	bit26 states are 60B9 with bit1 and bit2 with logic, bit27 states are 60B9 with bit9 and bit10 with logic					
2152h	Its subindices 01h and 02h can be written to 17 or 18 configured as probe 1 or probe 2 functions					

Additional notes for other bits:

bit0 and bit8 of 60B8h: The enable and stop control bits of probe 1 and probe 2, respectively, are valid for the rising edge.

The bit1 and bit9:probe modes of the 60B8h are divided into single-shot mode and continuous mode

One-shot mode: After the probe is started, it is captured only under the first trigger signal. In order to capture the new position value again, the 60B8 object must be given a rising edge signal to reactivate the probe action.

Continuous mode: After the probe is started, the capture action is performed under each trigger signal.

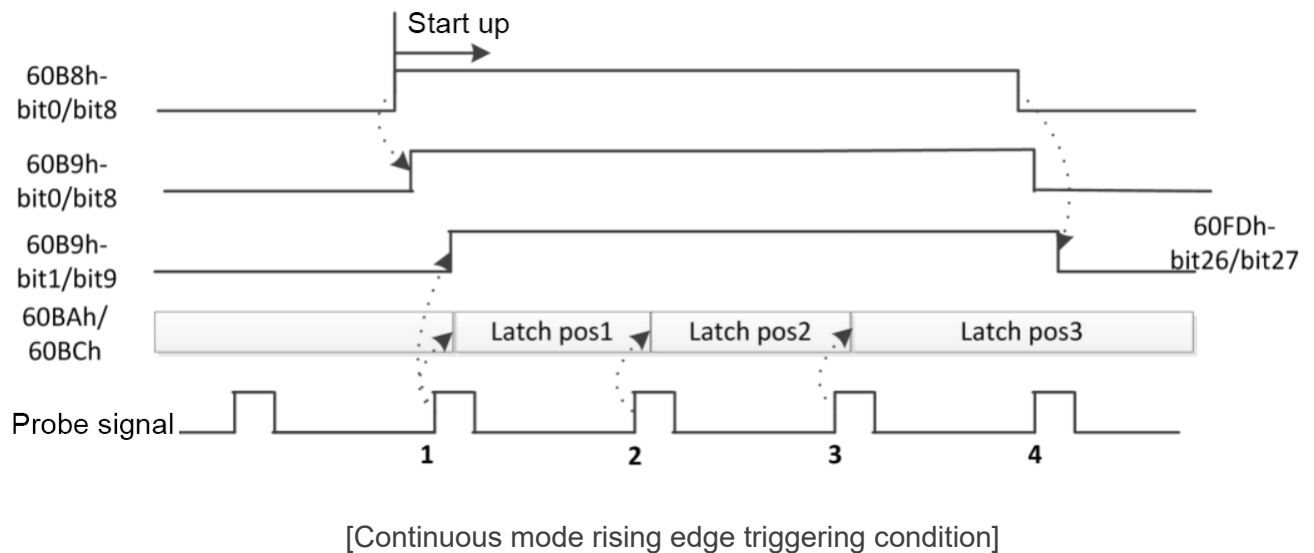
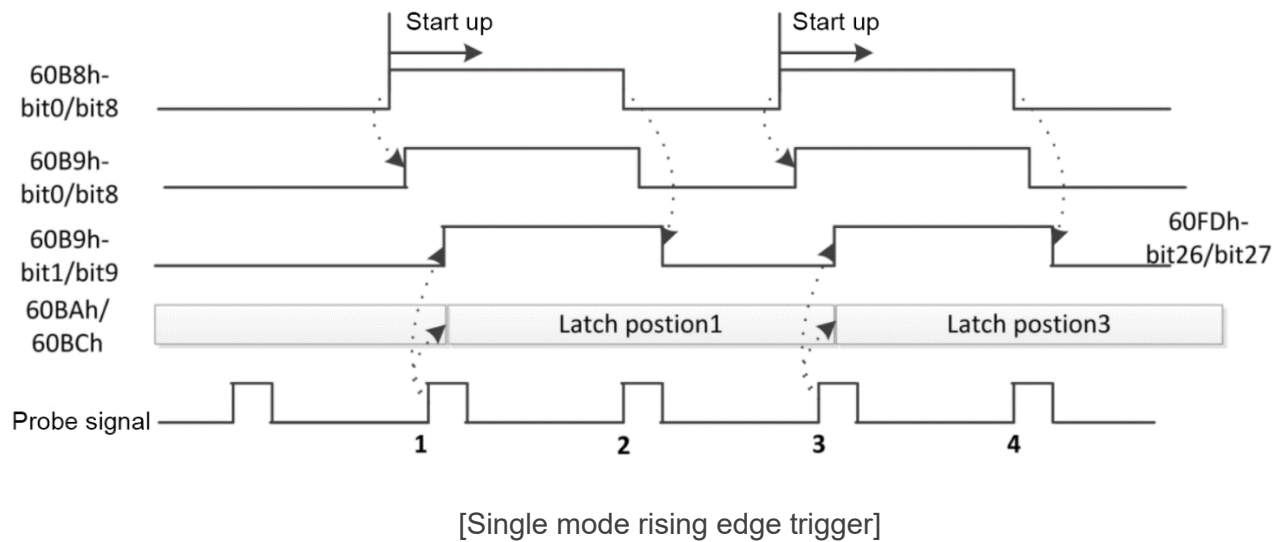

10.3 Encoder resolution

The encoder resolution of this driver is 10000 and matches the 2500-line encoder motor by default. If the user is using a 5000-wire encoder motor, the encoder resolution needs to be changed to 20000 (4 times). The encoder resolution can be set via the object dictionary of the master PLC, which is: 0x20F6. It is also possible to debug the software settings through the host computer.

set as shown below :

Object dictionary	Name	Attribute	Word	Range	Default value	Unit	Remark
20F6	Encoder resolution	RW	1	200~4096	4000		Resolution = Number of encoder lines x 4.

10.4 Encoder resolution

If the motor of the 42 and below base is matched, before connecting the motor for the first time, be sure to modify the peak current output of the drive to prevent the output current from burning the motor if the output current is too large.

Modify the output peak current can be set through the object dictionary of the master PLC, the object dictionary is : 0x20F1, or modified by the host computer debugging software, as shown below :

Object dictionary	Name	Attribute	Word	Range	Default value	Unit	Remark
20F1	Current Setting	RW	1	0~3000	1000	0.1%A	

10.5 603F Failure code

Description of the fault

603F object	Meaning
0x2211	Overcurrent fault
0x7120	The motor is open
0x3220	Undervoltage
0x3210	Overvoltage
0x8611	Position error is too large error
0xFF23	Emergency stop
0xFF19	The location follows the error
0xFF18	Motor overspeed
0xFF32	Communication is unstable

Appendix 1 : Return to Origin Method

This drive product supports the return to the origin mode of Z signal from 1 to 14 and 17 to 34,35. The specific definition and return to the origin process are described below.

Method 1:

If the negative limit is invalid, the motor will move in the negative direction at high speed at the origin until the negative limit switch signal is effective. The motor will stop abruptly and start moving forward at low speed at the origin. The first one after leaving the negative limit switch will stop moving when the encoder Z signal is effective, as shown in Figure A below.

If the motor stops at the negative limit position when it starts moving at the origin, the motor will move forward at the low speed of the origin and stop the first time after leaving the negative limit switch when the encoder Z signal is in effect.

If the positive limit signal is effective during the movement, the status word (6041h) bit 13 will be effective, indicating that the origin motion is wrong, and the motor will stop immediately.

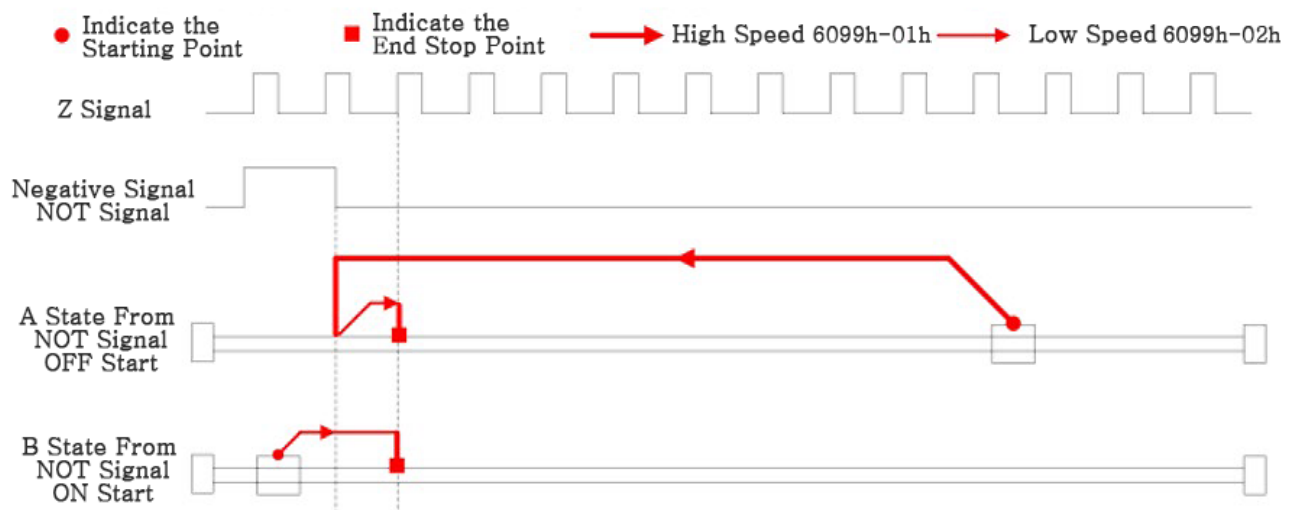

Method 1 Diagram

Method 2:

If the positive limit is invalid, the motor will move in the positive direction at high speed at the origin until the positive limit switch signal is effective. The motor will stop and move at low speed at the origin in the negative direction. When the first encoder Z signal after leaving the negative limit switch is effective, the motor will stop moving, as shown in Figure A below.

If the motor stops at the positive-limit position when it starts moving at the origin, it will move at the origin low speed negatively and stop when the first Z-signal after leaving the positive-limit switch is in effect.

If the negative limit signal is effective during the movement, the status word (6041h) bit 13 will be effective, indicating that the origin motion is wrong, and the motor will stop immediately.

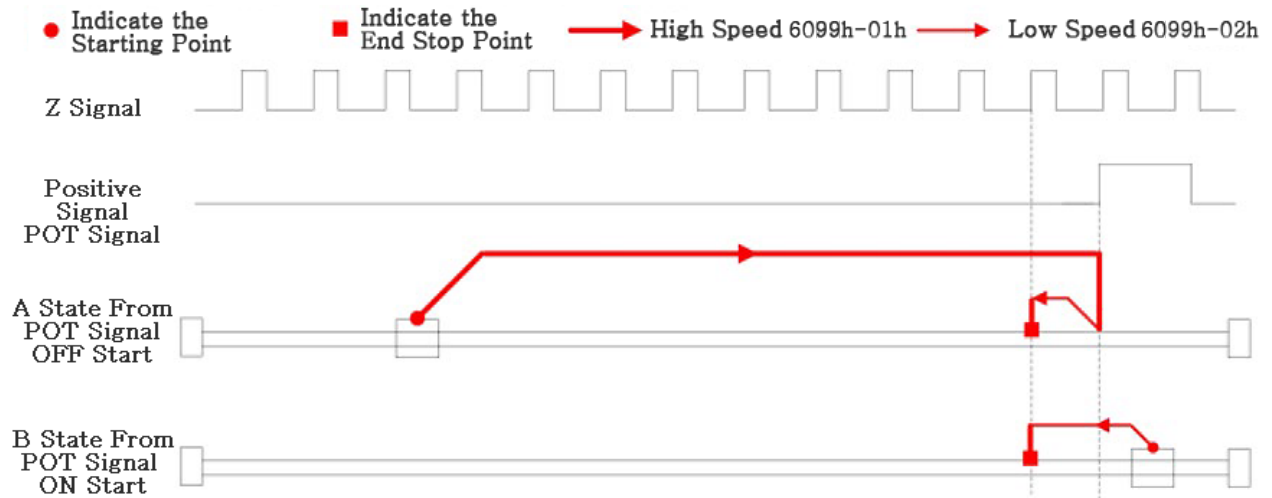

Method 2 Diagram

Method 3:

If the origin signal is invalid, the motor will move in A positive direction at A high speed at the origin until the origin signal is effective. The motor will stop and move at A low speed at the origin in A negative direction. When the first encoder Z signal after leaving the origin switch is effective, the motor will stop moving, as shown in FIG. A.

If the motor stops at the origin signal switch position when starting the origin motion, then the motor will move negatively at the origin low speed and stop when the first Z signal after leaving the origin switch is valid

If the limit signal is effective during the movement, the status word (6041h) bit 13 will be effective, indicating that the origin motion is wrong, and the motor will stop immediately.

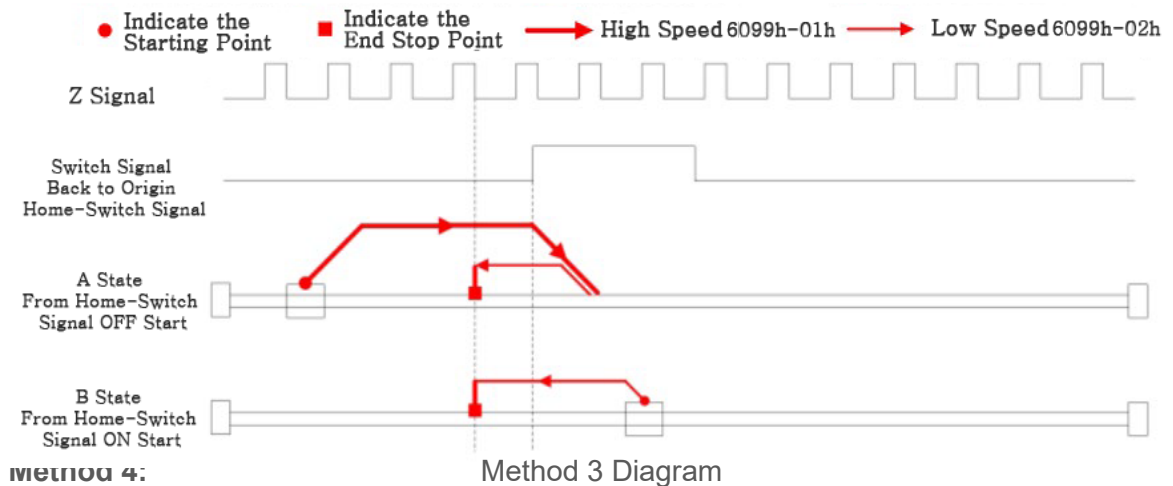

Method 4:

Method 3 Diagram

If the origin signal is invalid, the motor will move forward at low speed at the origin until the first encoder Z signal after the origin signal is valid stops, as shown in FIG. 7-4.

If the motor stops at the switch position of the origin signal when it starts to move at the origin, it will move at high speed at the origin in the negative direction until the origin signal is invalid and the motor slows down to stop and moves at low speed at the origin in the forward direction. It will stop moving when the first encoder Z signal after the origin signal is effective, as shown in Figure B.

If the limit signal is effective during the movement, the status word (6041h) bit 13 will be effective, indicating that the origin motion is wrong, and the motor will stop immediately.

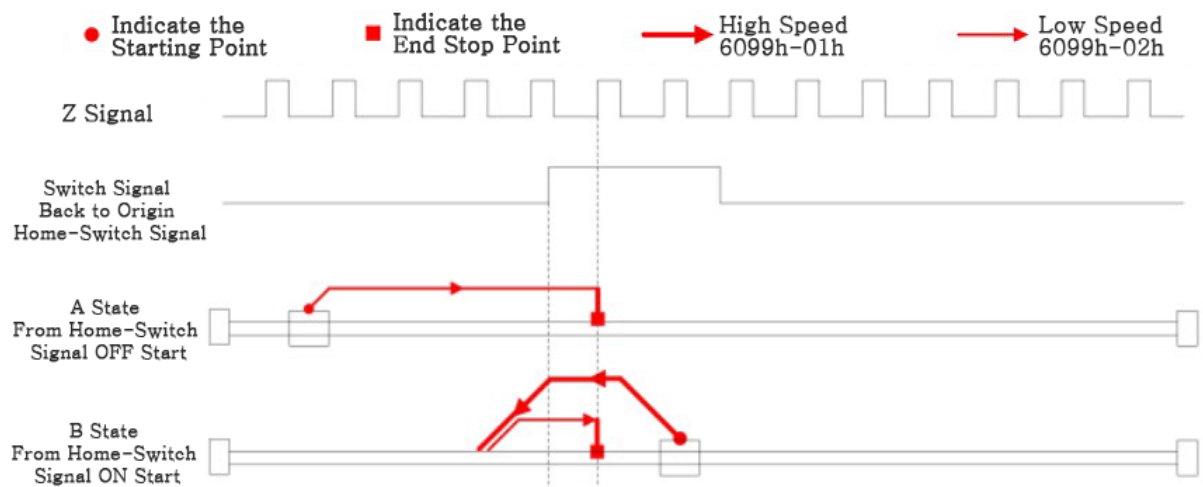

Method 4 Diagram

Method 5:

If the origin signal is invalid, the motor will move in A negative direction at A high speed at the origin until the origin signal is valid. After the motor slows down and stops, it will move at A low speed at the origin in A positive direction. When the first encoder Z signal after leaving the origin signal switch is valid, the motor will stop moving, as shown in Figure A.

If the motor stops at the origin signal switch position when it starts to move at the origin, it will move forward at the origin low speed and stop when the first Z signal after leaving the origin signal switch is effective, as shown in Figure B.

If the limit signal is effective during the movement, the status word (6041h) bit 13 will be effective, indicating that the origin motion is wrong, and the motor will stop immediately.

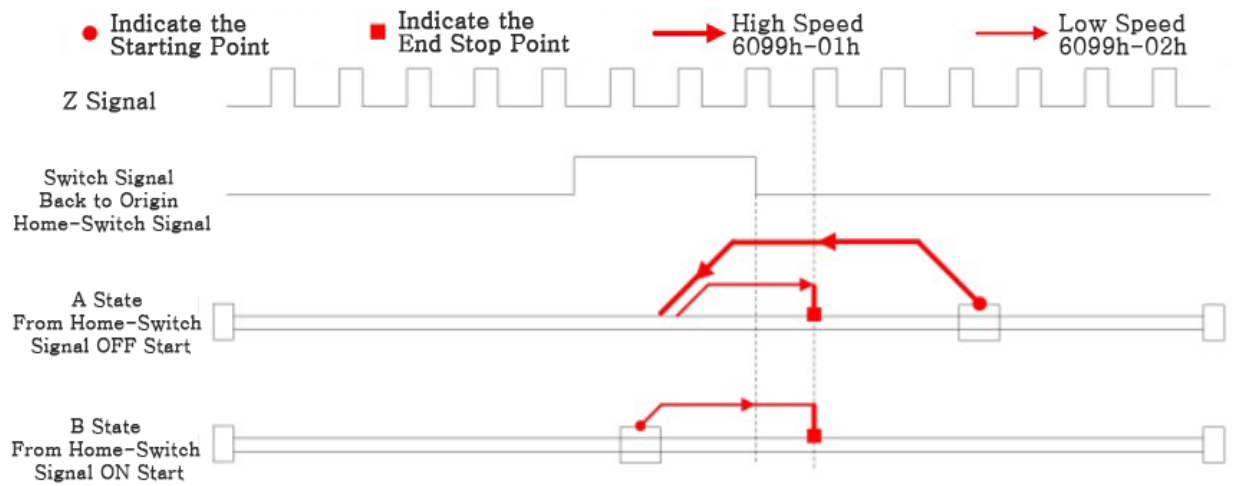

Method 5 Diagram

Methods 6:

If the origin signal is invalid, the motor will move in the negative direction at low speed at the origin until the first encoder Z signal with valid origin signal stops moving, as shown in Figure A.

If the motor stops at the origin signal switch position when it starts to move at the origin, it will move forward at a high speed at the origin, slow down and stop when it leaves the origin signal switch, and then move in the opposite direction at a low speed at the origin until it stops when the first Z signal with valid origin signal is valid, as shown in Figure B.

If the limit signal is effective during the movement, the status word (6041h) bit 13 will be effective, indicating that the origin motion is wrong, and the motor will stop immediately.

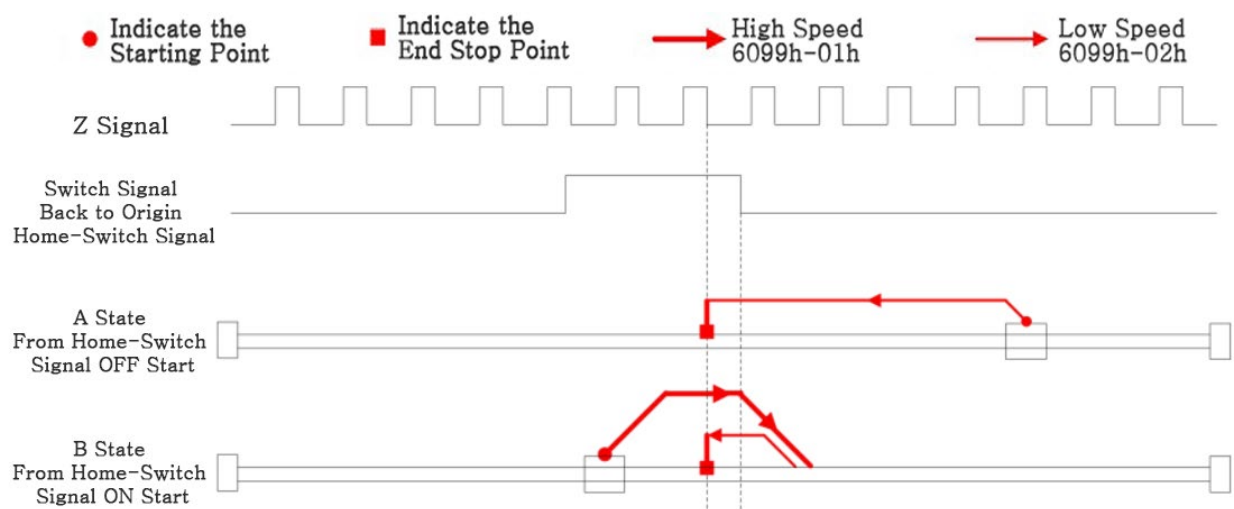

Method 6 Diagram

Methods 7:

If both the origin signal and the positive limit signal are invalid, the motor will move in the positive direction at high speed at the origin until the origin signal is effective, and then move in the negative direction at low speed at the origin, and stop when the first encoder Z signal leaving the origin signal switch is effective, as shown in FIG. A.

If the positive limit is invalid, the motor will stop at the origin signal switch position when it starts to move at the origin. The motor will move at the origin low speed negatively, and stop when the first Z signal leaving the origin signal switch is effective, as shown in Figure B.

If the origin signal and the signal is invalid is limit, the motor will be positive to origin of high-speed movement, until the limit is effectively stop signal, and then the negative direction to the origin low-speed movement, to continue movement in the origin signal is valid, until leave the origin signal switch Z first encoder signal effectively stop motion, as shown in figure C.

If the negative limit signal is effective during the movement, the status word (6041h) bit 13 will be effective, indicating that the origin motion is wrong, and the motor will stop immediately.

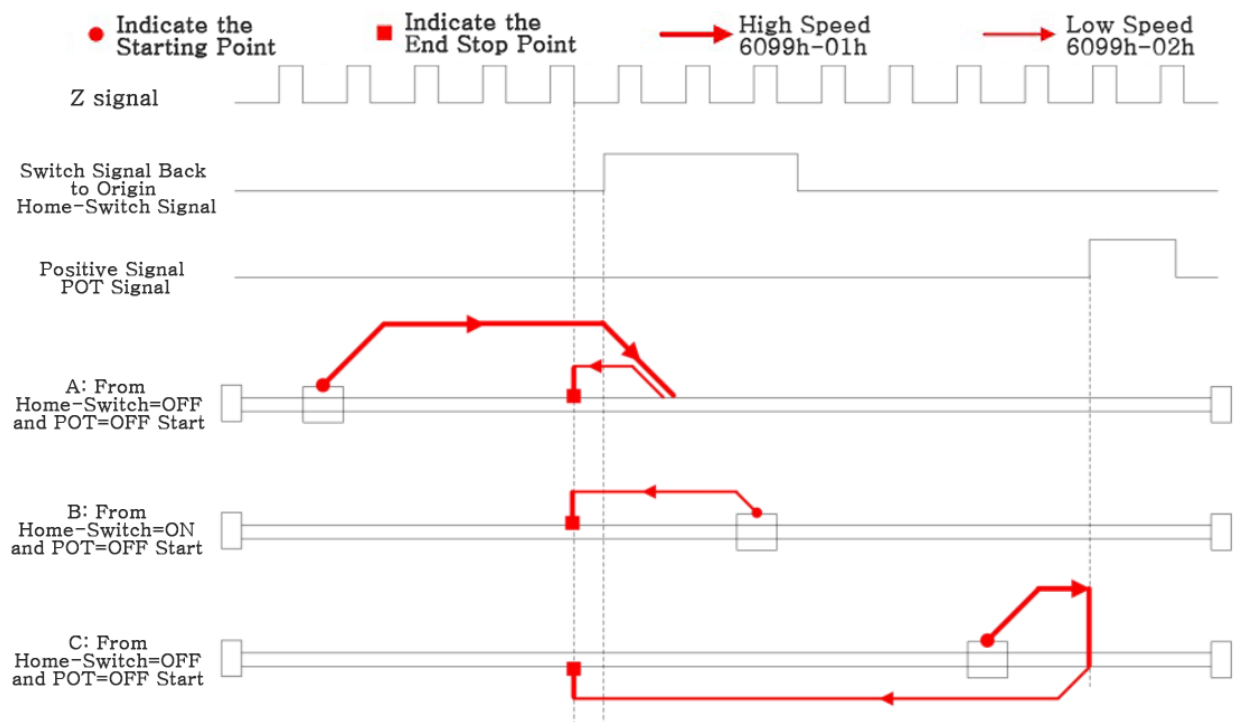

Method 7 Diagram

Methods 8:

If both the origin signal and the positive limit signal are invalid, the motor will move in the positive direction at low speed at the origin and stop moving when the first encoder Z signal with valid origin signal is valid,

as shown in FIG. A.

If the positive limit is invalid, the motor will stop at the origin signal switch position when it starts to move at the origin, and move at a high speed at the origin in a negative direction. After leaving the origin signal switch, the motor will slow down and stop, and then move at a low speed in a positive direction, and stop when the first Z signal after the origin signal is effective, as shown in Figure B.

If the origin signal and the signal is invalid is limit, the motor will be positive in origin of low speed movement, until the limit is effectively stop signal, and then the negative direction to the origin high-speed movement, to continue movement in the origin signal is valid, until after leaving the origin signal switch to slow down to stop, and then to forward to origin of low-speed movement, and then at the origin signal Z effective after the first encoder signal effectively stop motion, as shown in figure C.

If the negative limit signal is effective during the movement, the status word (6041h) bit 13 will be effective, indicating that the origin motion is wrong, and the motor will stop immediately.

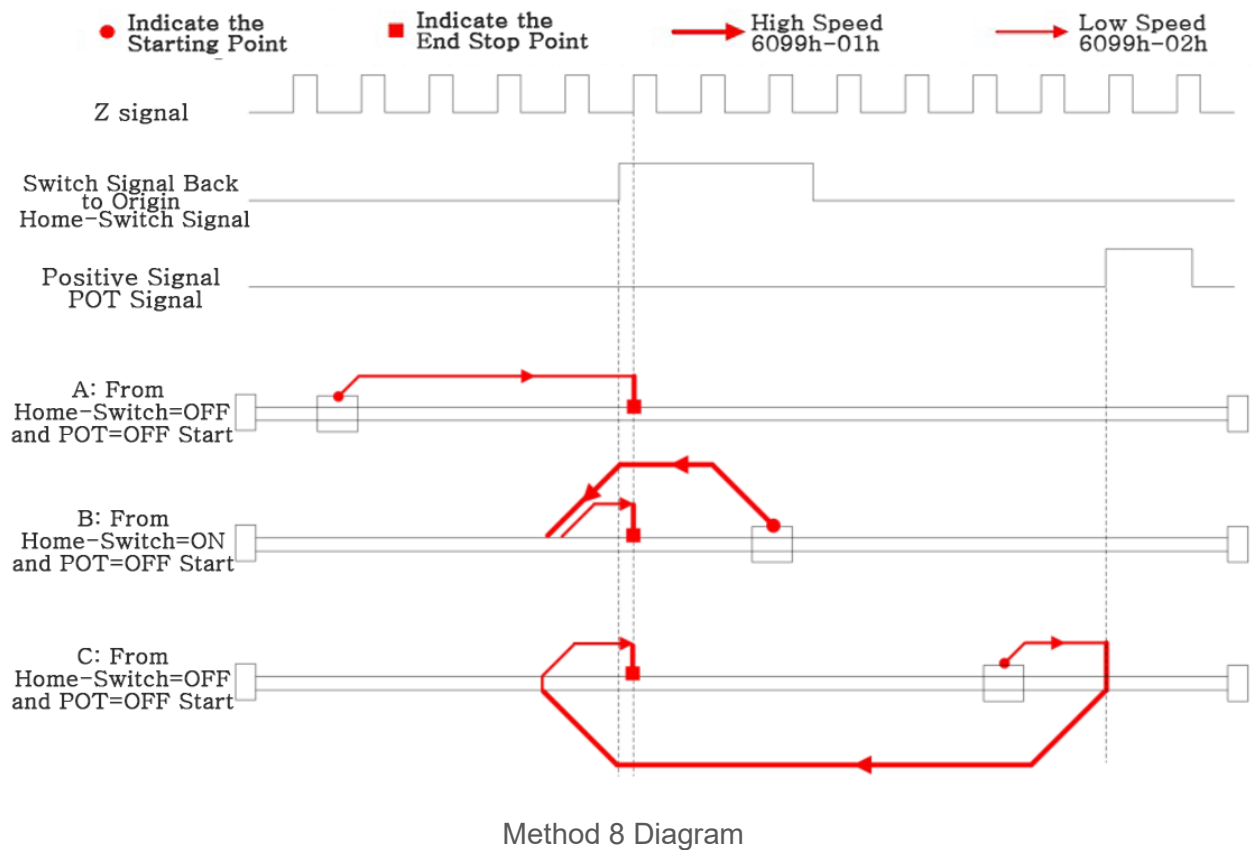

Method 8 Diagram

Methods 9:

If the origin signal and the signal is invalid is limit, the motor will toward the positive direction to origin of high-speed movement, the origin signal is valid to continue to exercise, slow stop when leaving the origin signal switch, then turn negative origin in slow motion, until the origin signal Z effective after the first encoder signal effectively stop motion, as shown in figure A.

If the positive limit is invalid, the motor will stop at the origin signal switch position when it starts to move at the origin. The motor will move at a high speed forward at the origin, slow down after leaving the origin signal switch, then move at a low speed at the origin in a negative direction, and stop when the first Z signal after the origin signal is valid, as shown in Figure B.

If both the origin signal and the positive limit signal are invalid, the motor will move at high speed towards the origin until the positive limit signal is effectively stopped, and then move at low speed towards the origin in the negative direction. It will stop moving when the first encoder Z signal after the origin signal is effective, as shown in FIG. C.

If the negative limit signal is effective during the movement, the status word (6041h) bit 13 will be effective, indicating that the origin motion is wrong, and the motor will stop immediately.

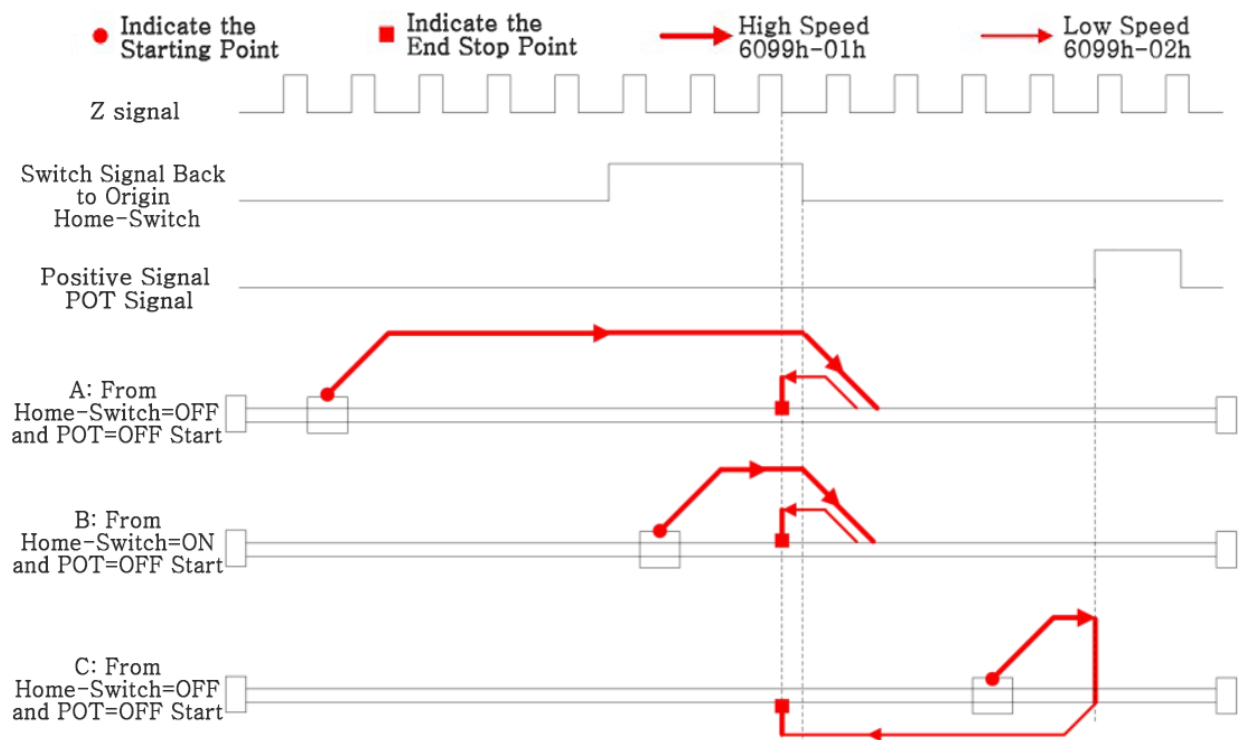

Method 9 Diagram

Methods 10:

If both the origin signal and the positive limit signal are invalid, the motor will move in the positive direction at the low speed of the origin. When the origin signal is valid, the motor will continue to move until the first encoder Z signal after the origin signal is invalid stops moving, as shown in Figure A.

If the positive limit is invalid, the motor will stop at the switch position of the origin signal when it starts to move at the origin. The motor will move forward at low speed at the origin and stop when the first Z signal after the origin signal is invalid, as shown in Figure B.

If the origin signal and the signal is invalid is limit, the motor will be positive in origin of low speed movement, until is limit signals effectively after abrupt stop, and then the negative direction to high speed movement, the origin at the origin signal effectively and stop slowing down, and then to forward to origin low-speed movement, until the origin signal is invalid after the first encoder signal Z effective stop motion, as shown in figure C.

If the negative limit signal is effective during the movement, the status word (6041h) bit 13 will be effective, indicating that the origin motion is wrong, and the motor will stop immediately.

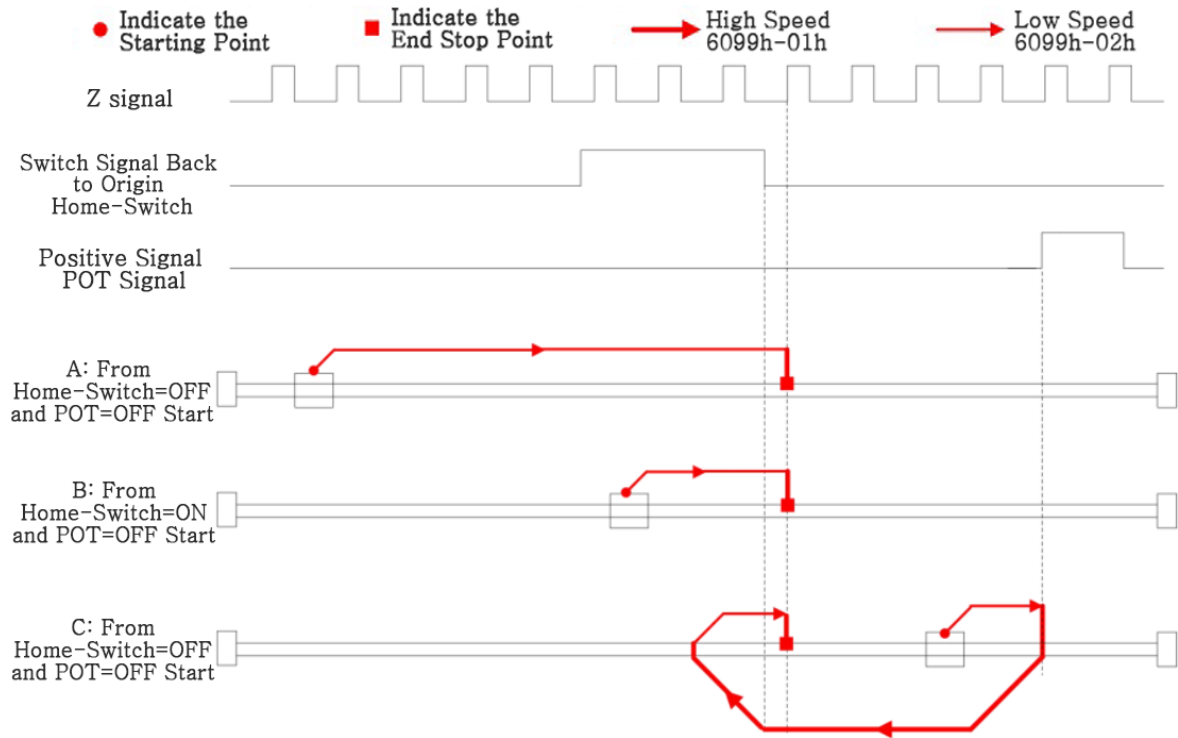

Method 10 Diagram

Methods 11

If both the origin signal and the negative limit signal are invalid, the motor will move at A high speed in the negative direction at the origin until the origin signal is effective, and then move at A low speed at the origin in the positive direction, and stop when the first encoder Z signal leaving the origin signal switch is effective, as shown in Figure A.

If the negative limit is invalid, the motor will stop at the origin signal switch position when it starts to move at the origin. The motor will move forward at the origin low speed and stop when the first Z signal leaving the origin signal switch is effective, as shown in Figure B.

If the origin signal and negative limit signal is invalid, the motor will toward the negative to the origin high-speed movement, until negative limit effectively stop signal, and then the positive direction to the origin, low-speed movement, to continue movement in the origin signal is valid, until leave the origin signal

switch Z first encoder signal effectively stop motion, as shown in figure C.

If the positive limit signal is effective during the movement, the status word (6041h) bit 13 will be effective, indicating that the origin motion is wrong, and the motor will stop immediately.

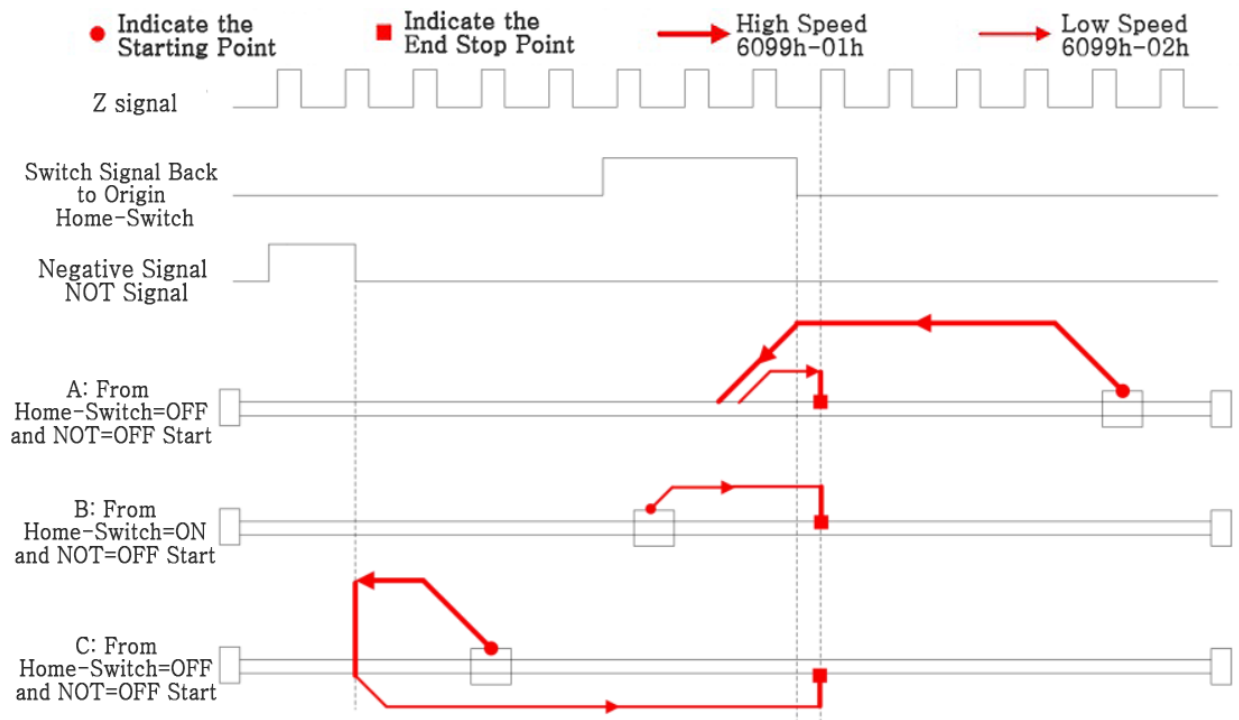

Method 11 Diagram

Methods 12:

If both the origin signal and the negative limit signal are invalid, the motor will move in the negative direction at low speed at the origin, and stop moving when the first encoder Z signal with valid origin signal is valid, as shown in FIG. A.

If the negative limit is invalid, the motor will stop at the origin signal switch position when it starts to move at the origin, and move at a high speed forward at the origin. After leaving the origin signal switch, the motor will slow down and stop, then move at a low speed at the origin negatively, and stop when the first Z signal after the origin signal is valid, as shown in Figure B.

If origin signals and negative limit are invalid, the motor will be toward the negative origin in slow motion, until negative limit effectively stop signal, and then the positive direction to the origin of high-speed movement, to continue movement in the origin signal is valid, until after leaving the origin signal switch to slow down to stop, then turn negative origin in slow motion, and then at the origin signal Z effective after the first encoder signal effectively stop motion, as shown in figure C.

If the positive limit signal is effective during the movement, the status word (6041h) bit 13 will be effective, indicating that the origin motion is wrong, and the motor will stop immediately.

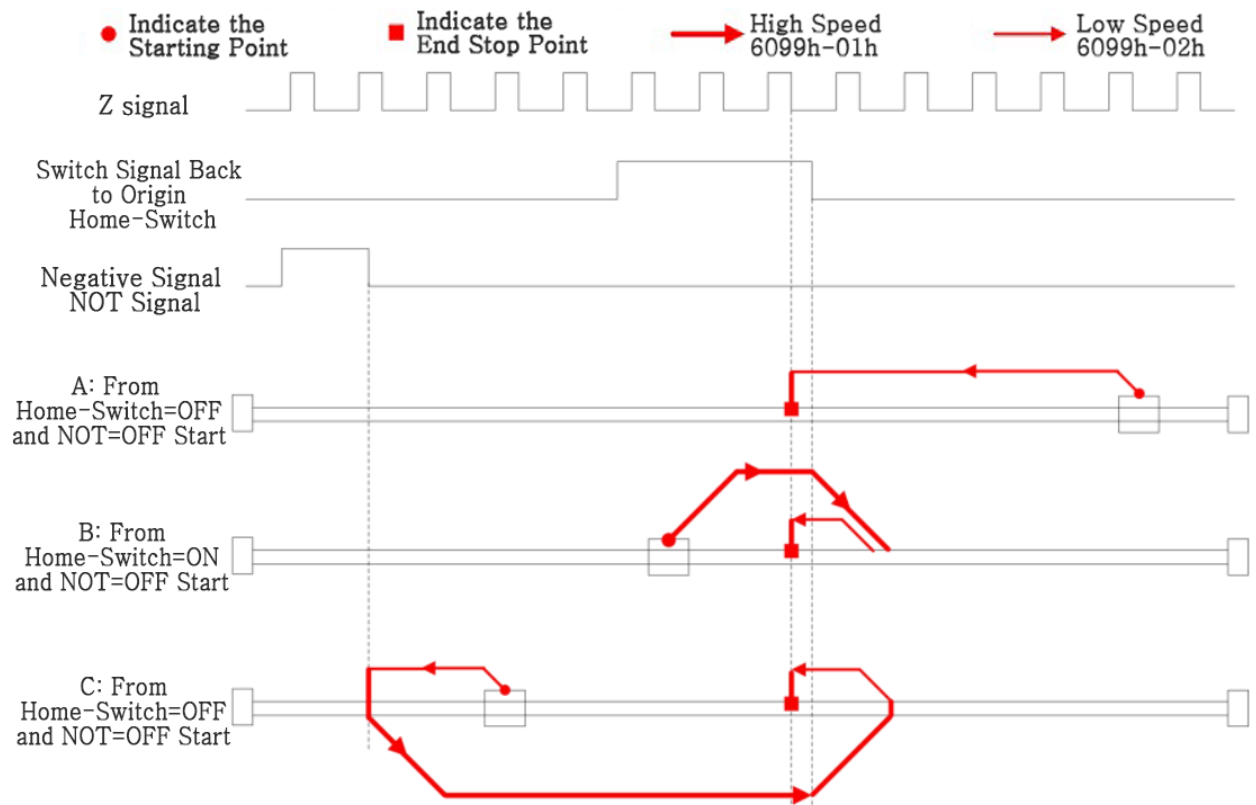

Method 12 Diagram

Methods 13:

If the origin signal and negative limit signal is invalid, the motor will be toward the negative direction of the origin in the high-speed movement, the origin signal is valid to continue movement, slowing down to stop when leaving the origin signal switch, and then to forward to origin low-speed movement, until the origin signal Z effective after the first encoder signal effectively stop moving, as shown in figure A.

If the negative limit is invalid, the motor will stop at the origin signal switch position when it starts to move at the origin, and will move at a high speed at the origin in a negative direction. After leaving the origin signal switch, the motor will slow down and stop, and then move at a low speed in a positive direction. It will stop when the first Z signal after the origin signal is effective, as shown in Figure B.

If both the origin signal and the negative limit signal are invalid, the motor will move at a high speed towards the negative limit signal until the negative limit signal is effectively stopped, then move at a low speed towards the positive direction, and stop when the first encoder Z signal after the origin signal is effective, as shown in FIG. C.

If the negative limit signal is effective during the movement, the status word (6041h) bit 13 will be effective, indicating that the origin motion is wrong, and the motor will stop immediately.

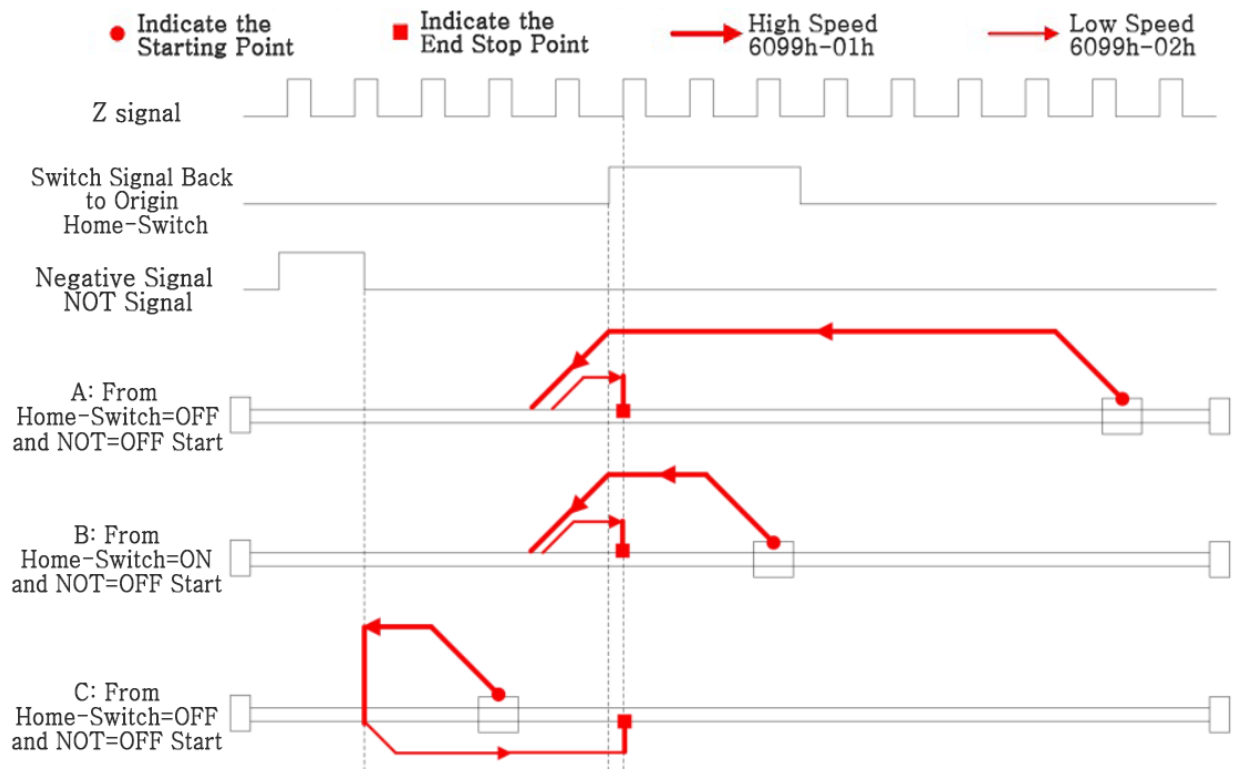

Method 13 Diagram

Methods 14:

If both the origin signal and the negative limit signal are invalid, the motor will move in the negative direction at the low speed of the origin. When the origin signal is valid, the motor will continue to move until the first encoder Z signal after the origin signal is invalid stops moving, as shown in Figure A.

If the negative limit is invalid, the motor will stop at the switch position of the origin signal when it starts to move at the origin. The motor will move at the low speed at the origin negatively, and stop when the first Z signal after the origin signal is invalid, as shown in Figure B.

If the origin signal and negative limit signal is invalid, the motor will be toward the negative origin in slow motion, until the stop after negative limit signals effectively, high speed movement, and then the positive direction to the origin at the origin signal effectively and stop slowing down, and then to negative origin in slow motion, Z until the origin signal is invalid after the first encoder signal effectively stop motion, as shown in figure C.

If the negative limit signal is effective during the movement, the status word (6041h) bit 13 will be effective, indicating that the origin motion is wrong, and the motor will stop immediately.

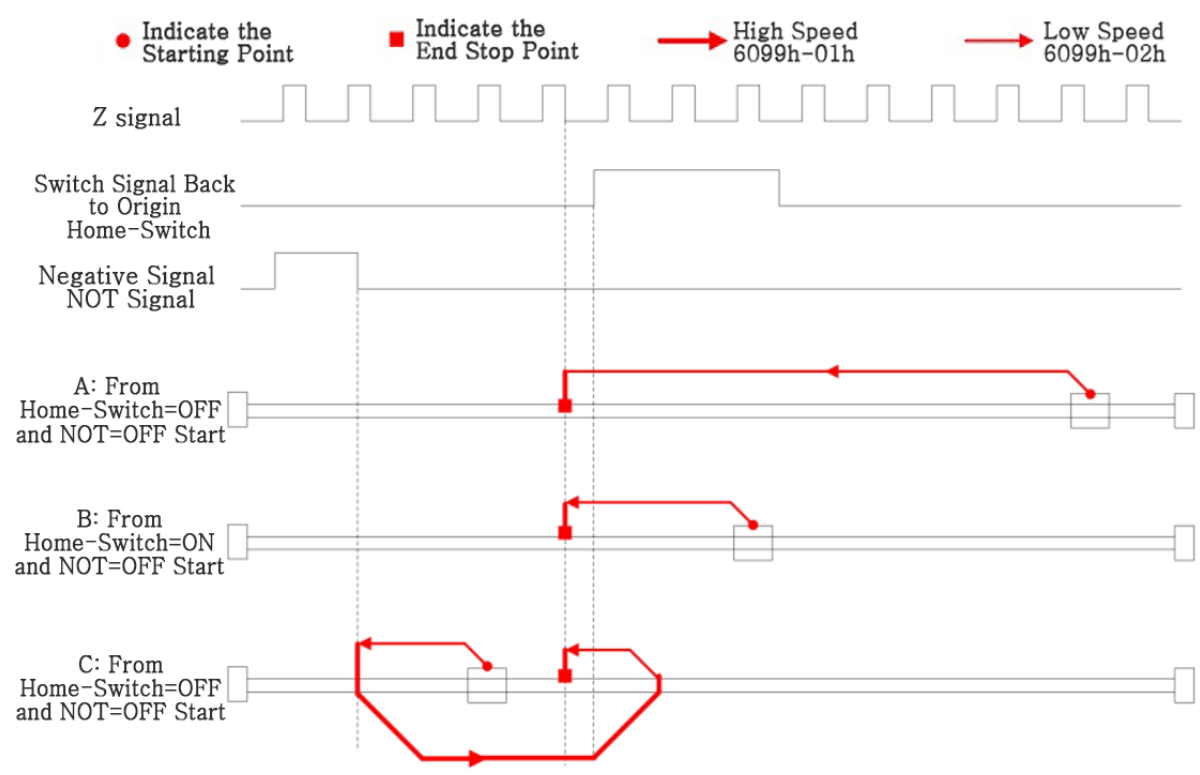

Method 14 Diagram

Methods 17:

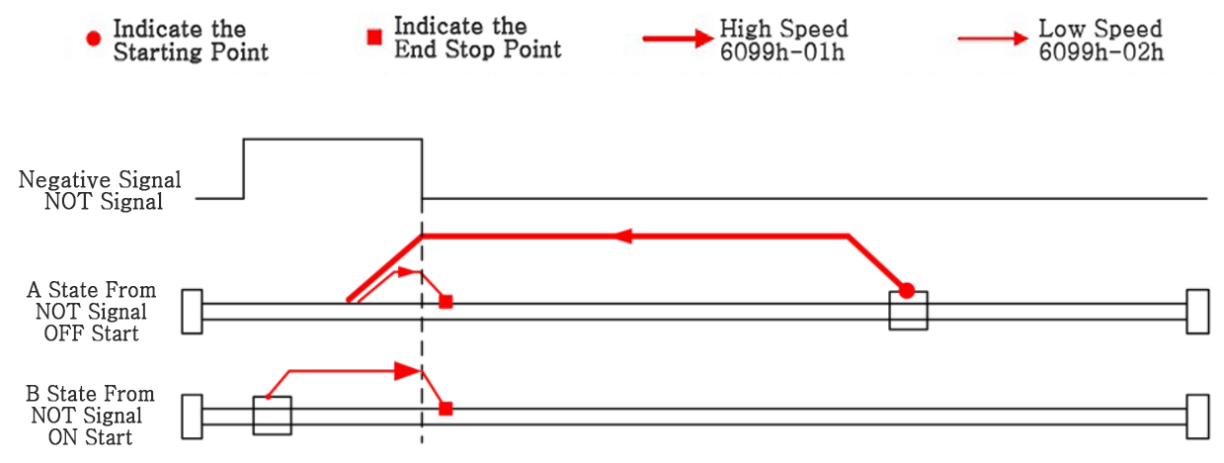

Method 17 Diagram

Method 18:

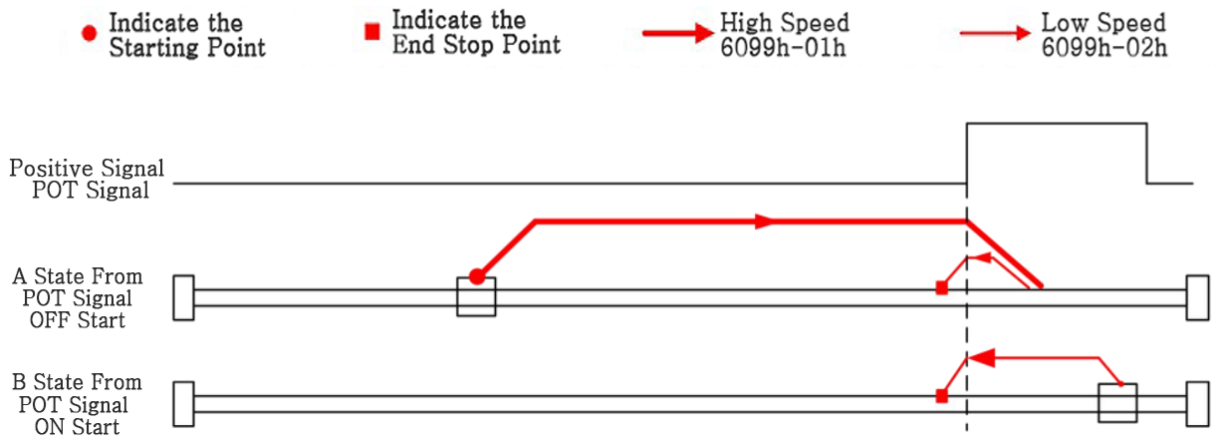

Method 18 Diagram

Method 19:

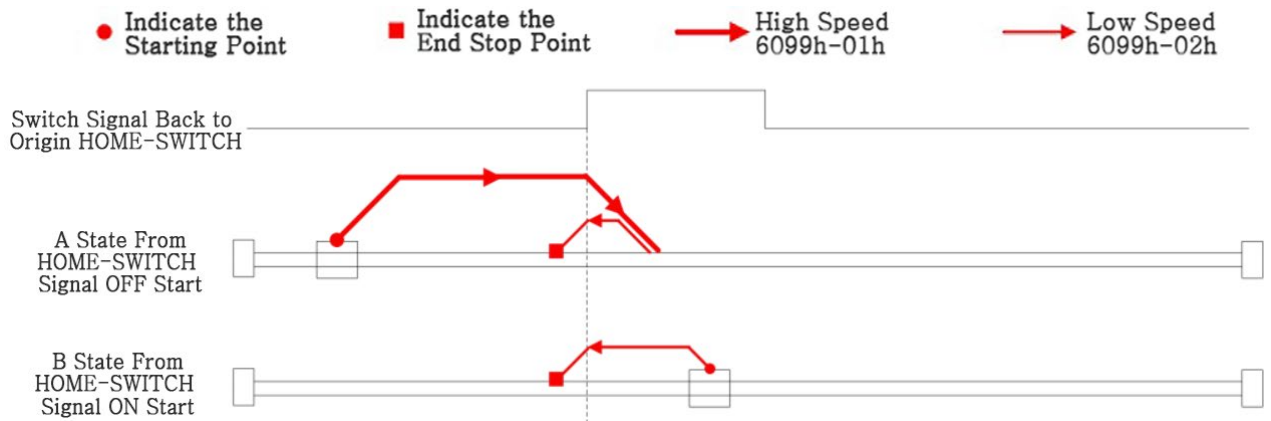

Method 19 Diagram

Method 20:

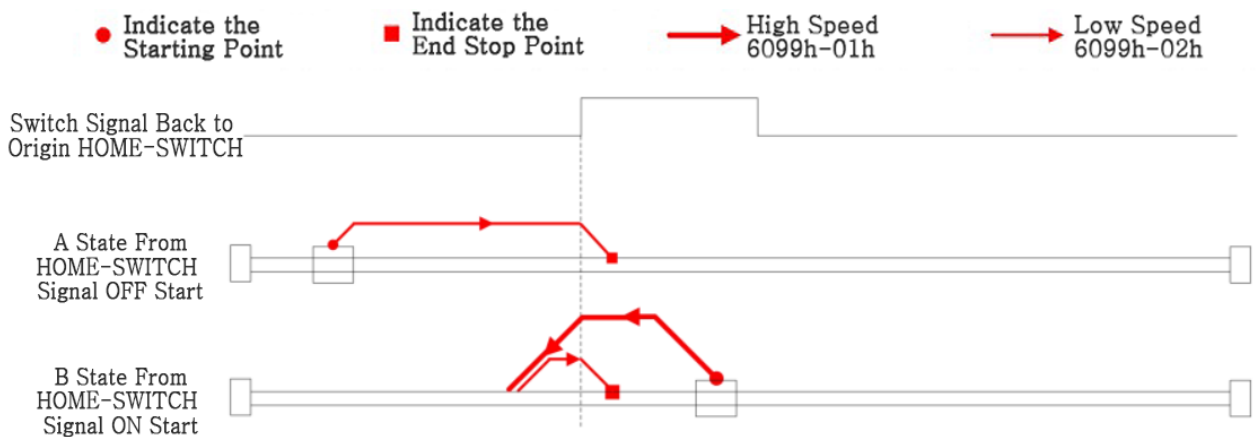

Method 20 Diagram

Method 21:

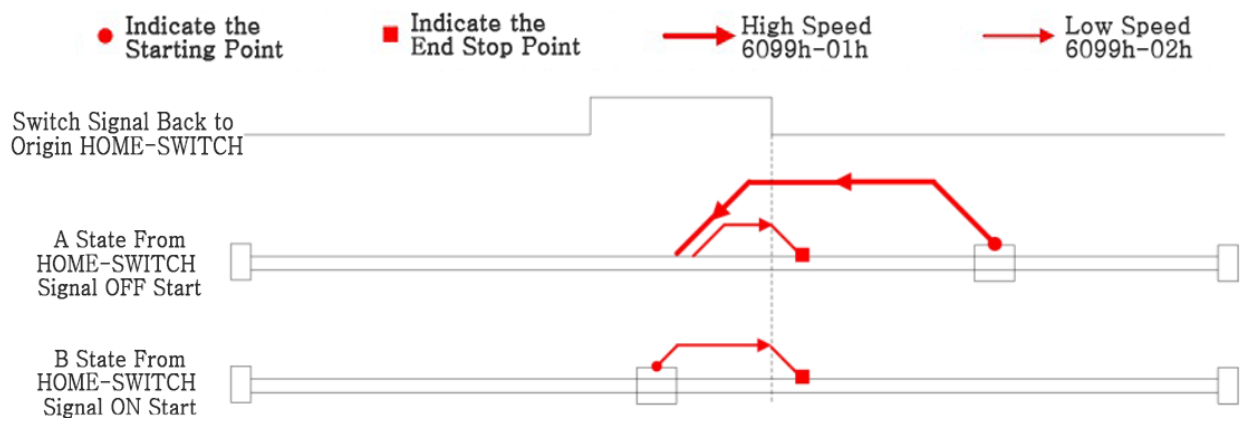

Method 21 Diagram

Method 22:

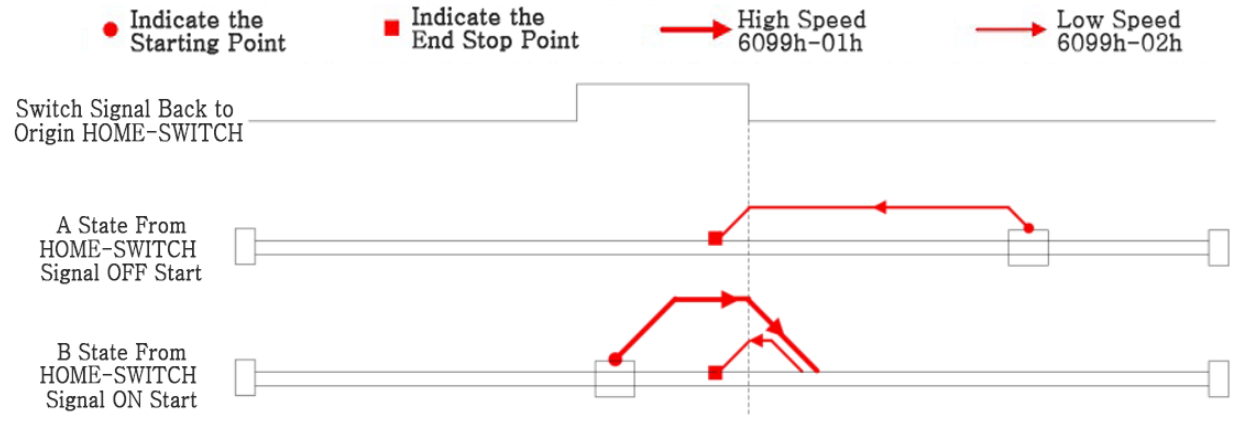

Method 22 Diagram

Method 23:

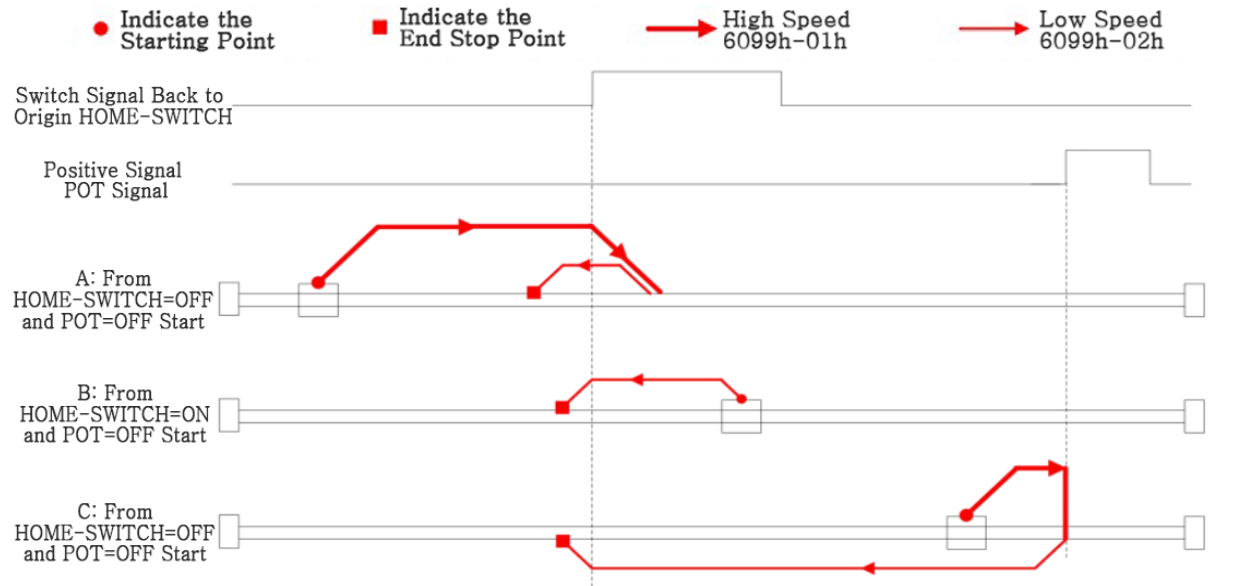

Method 23 Diagram

Method 24:

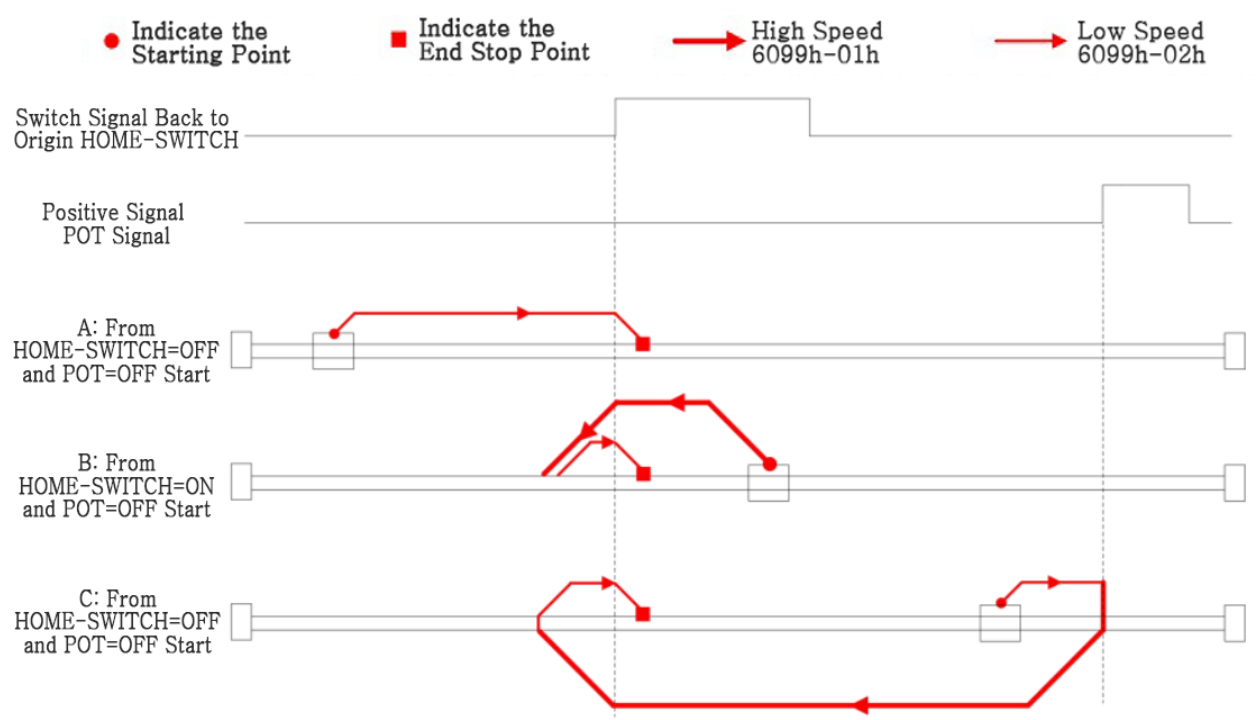

Method 24 Diagram

Method 25:

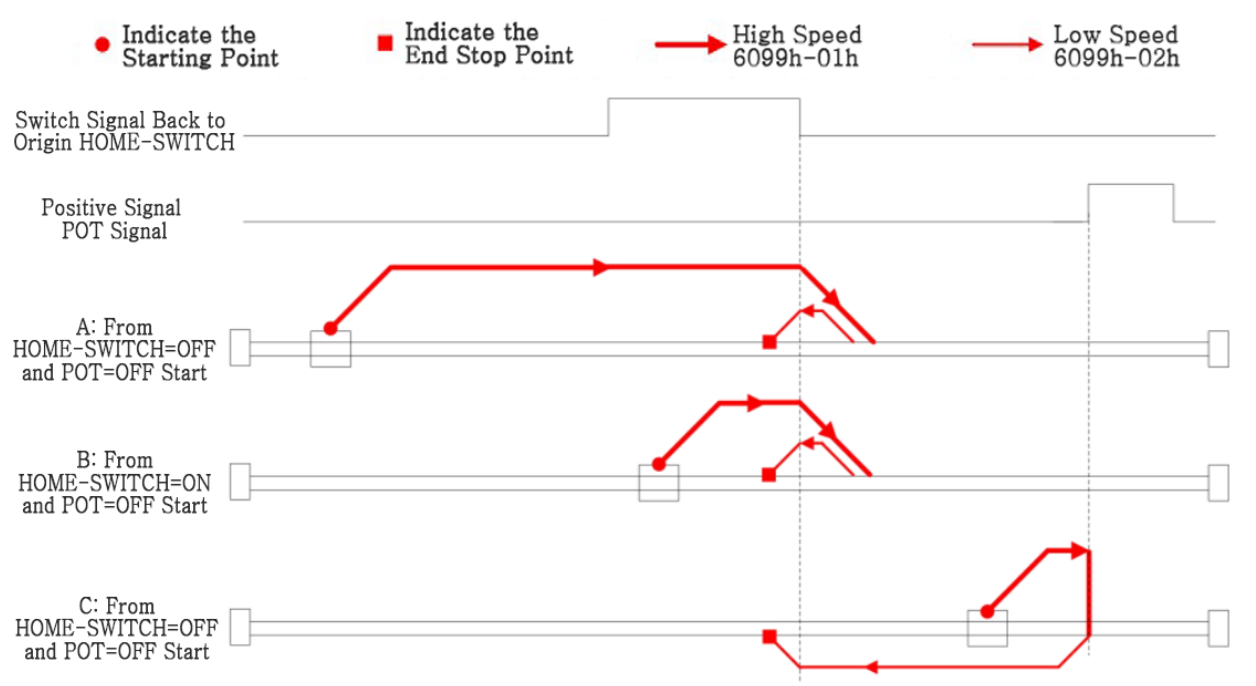

Method 25 Diagram

Method 26:

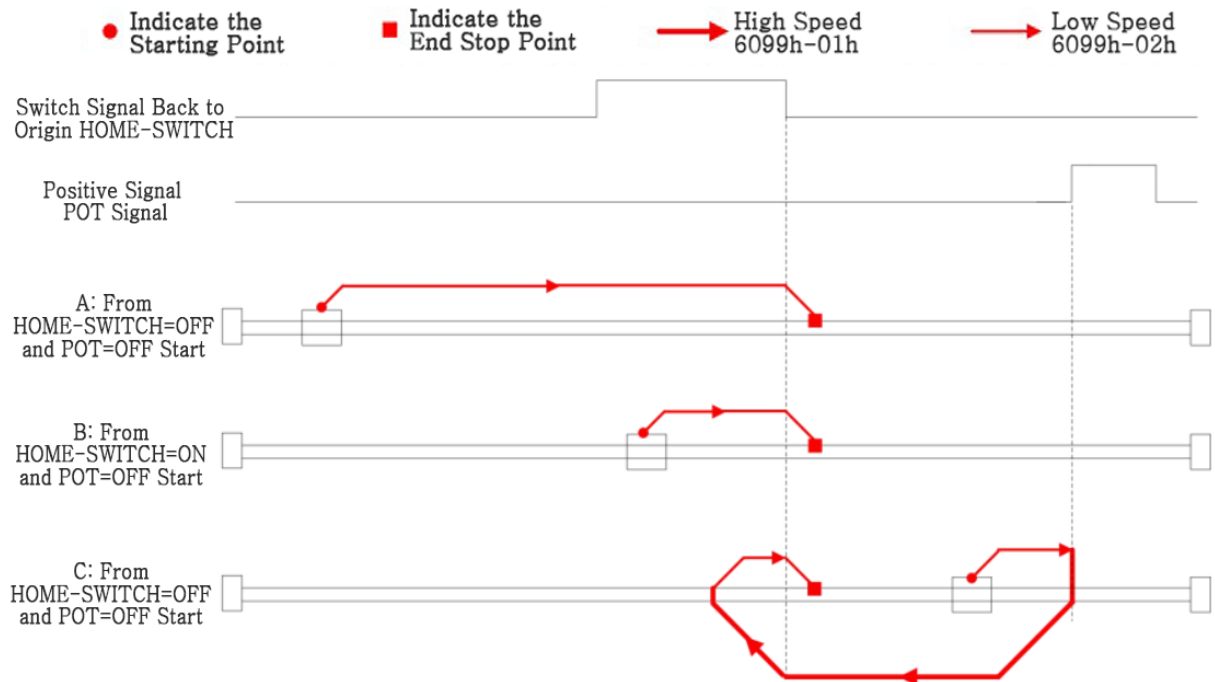

Method 26 Diagram

Method 27:

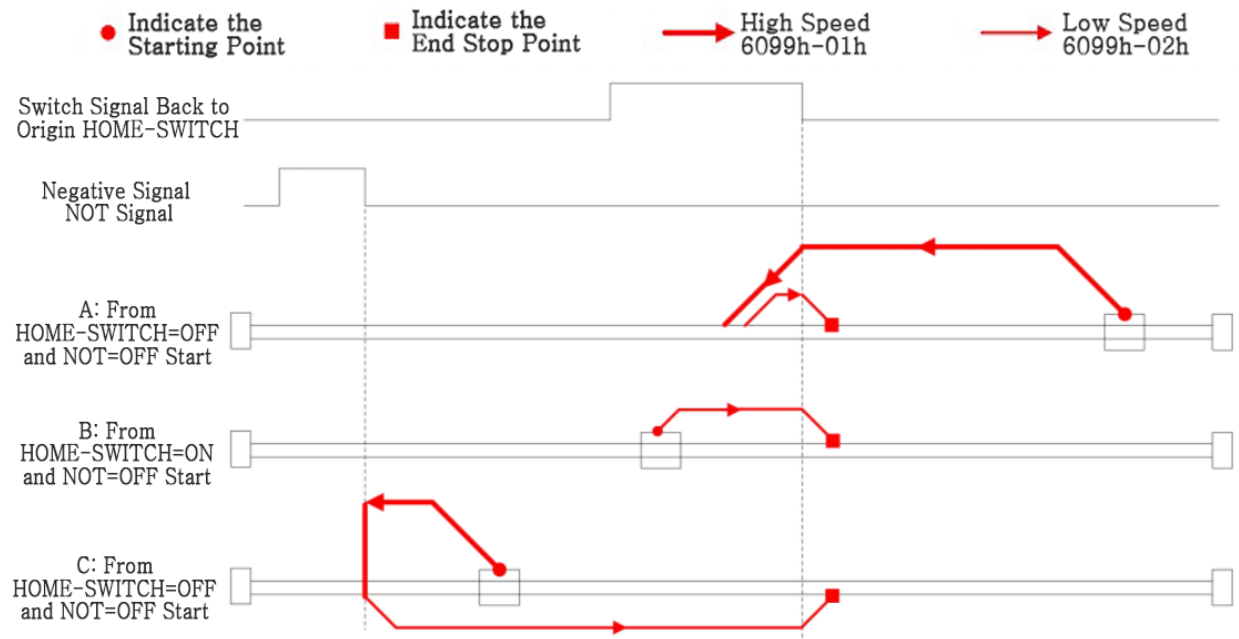

Method 27 Diagram

Method 28:

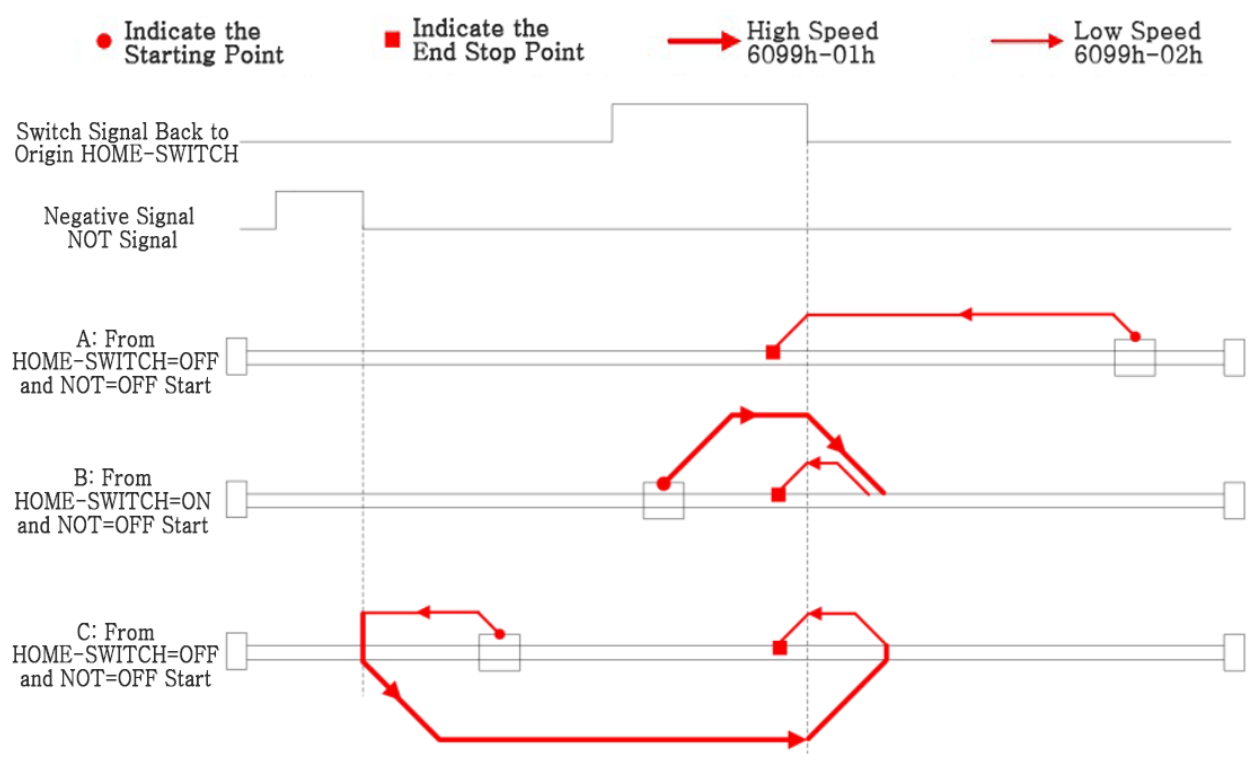

Method 28 Diagram

Method 29:

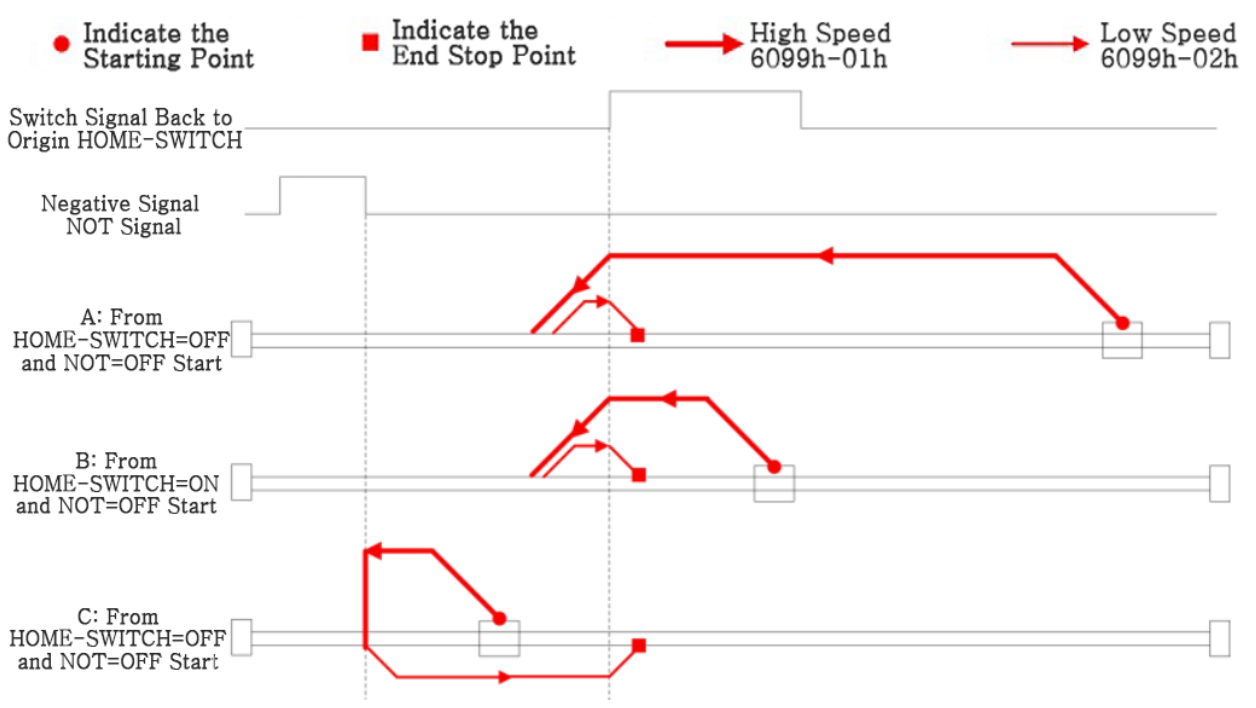

Method 29 Diagram

Method 30:

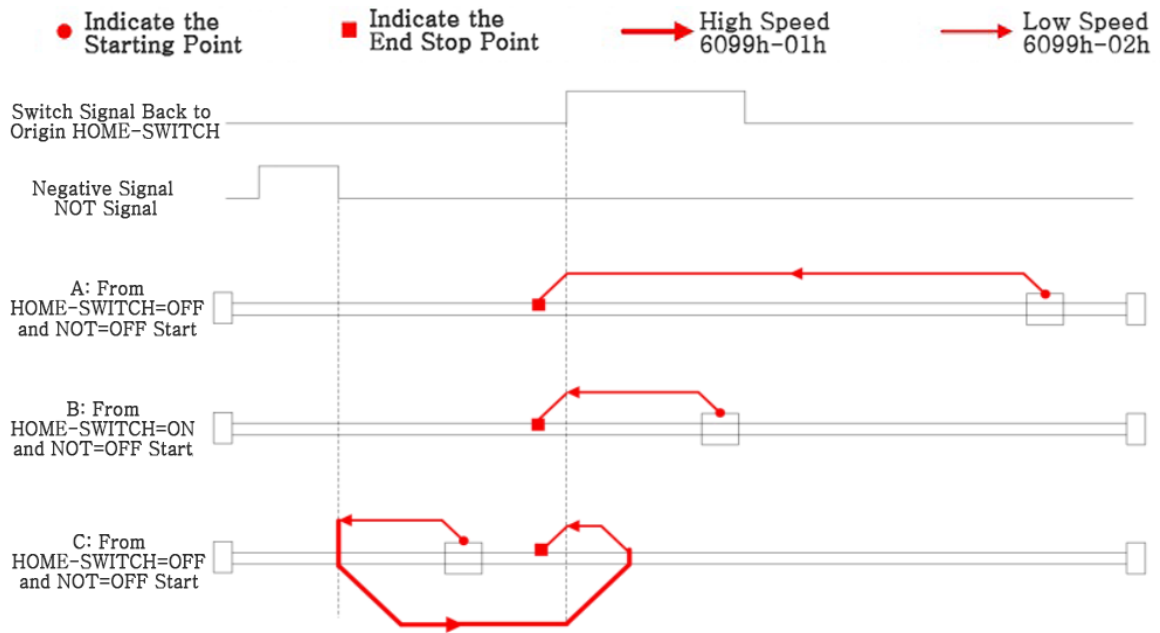

Method 30 Diagram

Method 33:

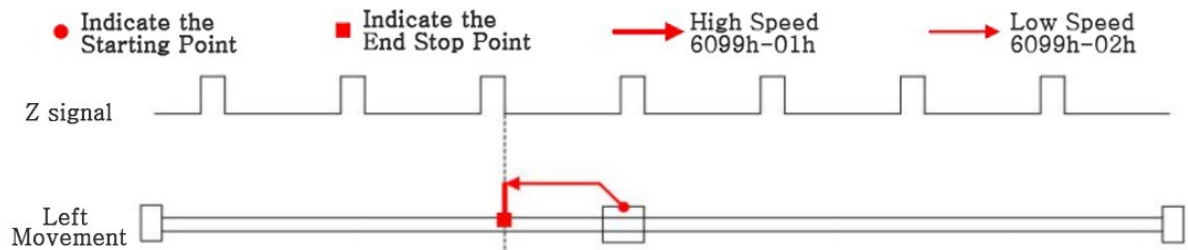

Method 33 Diagram

Method 34:

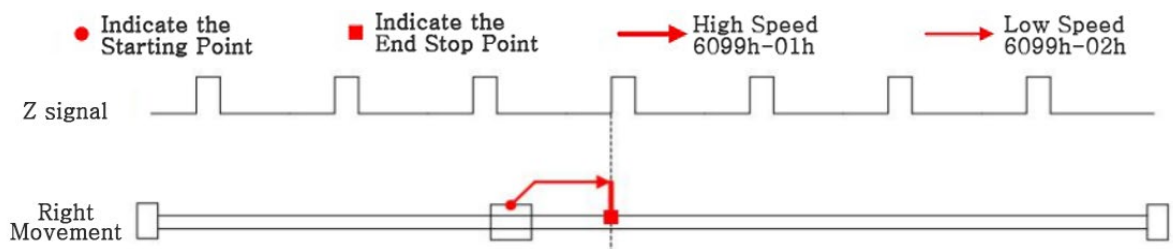

Method 34 Diagram

Method 35:

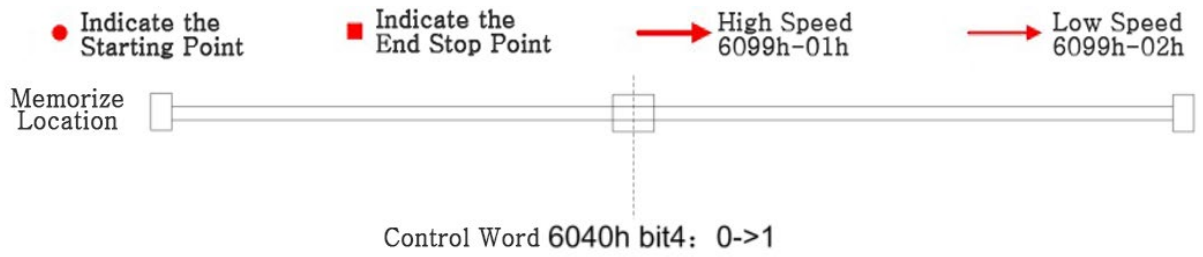



Method 35 Diagram

Appendix 2 : History of changes

Serial number	Version	Date of change	Illustrate
1	V 1.0	2023.07.27	First edition
2	V 1.1	2024.06.01	Second edition

 +86-0519-8517 7825

 +86-0519-8517 7807

 No. 2850 Luheng Road, Changzhou Economic
Development Zone, Jiangsu Province, China

 www.dingsmotion.com

International Customer

Person in Charge :

Daniel Jang

daniel@dingsmotion.com

No. 2850 Luheng Road, Changzhou
Economic Development Zone,
Jiangsu Province, China

+86-519-85177825, 85177826

North America Customer

Person in Charge :

Nicolas Ha

sales@dingsmotionusa.com

335 Cochrane Circle Morgan Hill,
CA 95037

+1-408-612-4970

China Customer

Person in Charge :

Sweet Shi

info@dingsmotion.com

No. 2850 Luheng Road, Changzhou
Economic Development Zone,
Jiangsu Province, China

+86-519-85177825, 85177826